



Energy Safe Technologies

PIR PREMIER AND PUR CLASSIC SANDWICH PANELS

Technical Catalog

CONTENTS

CHAPTER 1: GENERAL INFORMATION

1.1 History	3
1.2 Structure of sandwich panels	3
1.3 Polyurethane foam	3
1.4 What is the difference between Pur and Pir panels?	5
1.5 Why is PIR Premier better than other PIR systems? What is the secret of PIR Premier?	7
1.6 Metal facings	8
1.7 Production lines	9

CHAPTER 2: PARAMETERS AND FEATURES OF SANDWICH PANELS

2.1 Dimensional tolerances	11
2.2 Thermal conductivity, thermal transmission, and thermal resistance of PUR panels	13
2.3 Calculation of thermal transmittance and thermal resistance	15
2.4 Thermal insulating properties of building materials	17
2.5 Heat capacity	17
2.6 Thermal bridges and heat losses	18
2.7 Color	20

CHAPTER 3: EXTERNAL LOAD ON PANELS

3.1 Deformations due to surface temperature difference	21
3.2 Mechanical resistance of wall panels	21
3.3 Mechanical resistance of roof panels	28
3.4 Wrinkling stress	29
3.5 Uniformly distributed lateral load on vertical fixed panels / wind load on structures from sandwich panels	30
3.6 Vertical load on wall panels	36

CHAPTER 4: WALL AND ROOF SANDWICH PANELS BY PH INSULATION

4.1 Labeling	34
4.2 Geometry	34

CHAPTER 5: GENERAL RULES FOR HANDLING, CUTTING, TRANSPORTATION, AND STORAGE OF SANDWICH PANELS

5.1 Cutting	43
5.2 Packing, transportation, and storage	43

CHAPTER 6: FRAMELESS STRUCTURES WITH SANDWICH PANELS

6.1 General information	49
6.2 Structure and assembly of cold rooms	49
6.3 Metal elements of cold rooms	54
6.4 Insulation of walls with sandwich panel	58
6.5 Thickness of panels for cold rooms	58
6.6 Pressure equalizing valves	59

CHAPTER 1: GENERAL INFORMATION

1.1 HISTORY

Sandwich panels are extensively used in the construction of prefabricated buildings, cold storages, deep freeze rooms, manufacturing facilities and offices, as well as for other purposes. During the COVID-19 pandemic, infection hospitals and pavilions are erected using this technology.

With their high thermal insulation performance, sandwich panels reduce the costs of heating and conditioning. The energy savings, along with the fast speed of installation, is an important factor in their growing popularity. In 2005, the European Committee for Standardization adopted a unified standard, EN 14509-2005, to regulate the production and use of sandwich panels in the EU. PH Insulation panels with customized blend PIR Premier have CE certificate according to EN 14509 standard.

1.2 STRUCTURE OF SANDWICH PANELS

Sandwich panels consist of two rigid faces, usually made of metal, with a core layer between them that provides highest insulation possible. Thermal conductivity of PIR Premier panels is about 0.022 W/m·K. In March 2020, the Elastokam/BASF laboratory registered thermal conductivity of 0.0194 W/m·K for specimens of PIR Premier panels by PH Insulation.

Mineral wool, expanded polystyrene and glass wool are also popular core materials for sandwich panels.

There are three main elements required to make an efficient sandwich panel:

1. 40% depends on the quality of the PUR or PIR foam systems
2. 40% depends on the quality of the production line
3. 20% depends on having the professionals with the know-how to do the job

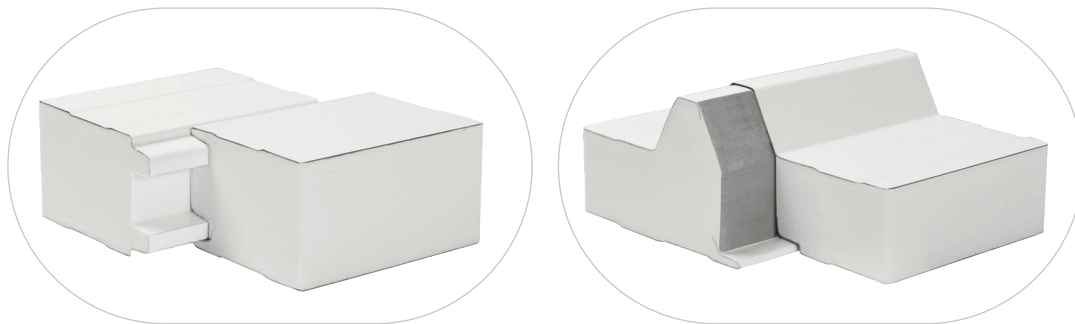

1.3 POLYURETHANE FOAM

Polyurethane is manufactured by polymerization and foaming, which occurs when two liquid components are mixed with a blowing agent and certain activators, accelerating the curing. The proportions of these components and additives determine the foam's density, rigidity and other mechanical properties, as well as the time needed for various phases of the reaction.

Figure 1.
Structure of a sandwich panel. Insulation core is between two thin metal faces

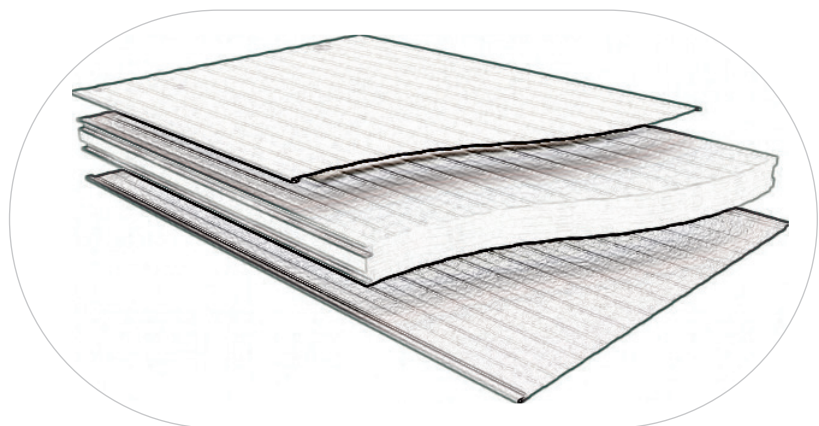

Polyurethane consists of small closed cells. Only 3% of the material is solid, the rest is gas trapped in these pores. Its density usually ranges from 24 to 96 kg/m³.

It is this porous structure that makes polyurethane a great option for insulation, because the thermal conductivity of gases is tens and hundreds times lower than that of solid materials.

PU foams are:

- Energy-saving – their thermal conductivity is as low as 0.020 W/m·K and reaches 0.018 W/m·K if advanced blowing agents are used.
- Eco-friendly – PU foams are everywhere from the soles of your shoes to the wheels of your car or to the insulation of fuel tanks in spacecraft. In Russia, they are approved for use in residential construction, since the order of Ministry of Health no. 07/6 561 on 26 December 1986.
- Healthy – they are used in the food industry for cold storage.
- Vapor- and waterproof.
- Resistant to mold and other fungi. Rodents and insects do not eat them either.
- Durable – they maintain their features even after fifty years.

PU foams are based on polyurethanes, which are polymeric compounds obtained through the chemical reaction of liquid isocyanates with liquid polyols. Depending on the proportion of these reagents, both soft and elastic or rigid foams with good insulating properties can be made.

Figure 2.
PU foam cells viewed
under 20× magnification.

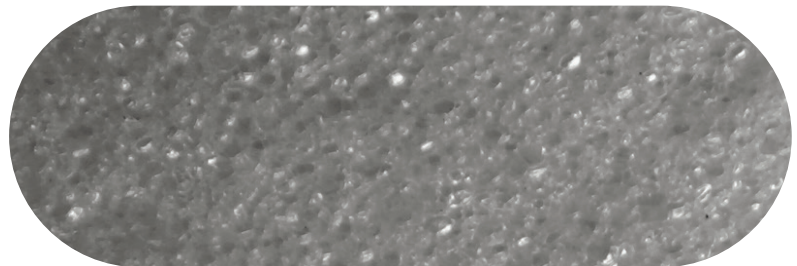
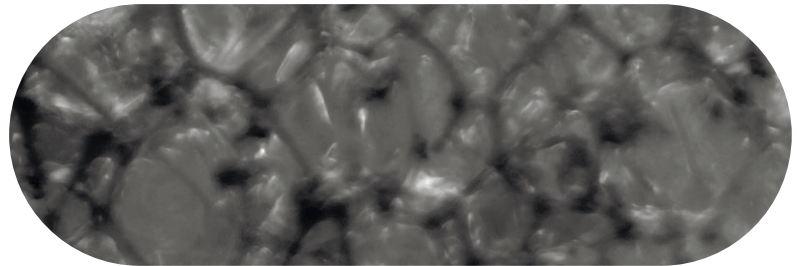

Figure 3.
PU foam cells viewed
under 300× magnification.



Due to their perfect insulation properties and the ability to withstand significant mechanical loads, rigid PU foams are widely used as a core in sandwich panels.

Losses of heat depend on thermal conductivity of the gas trapped within the cells of solid material, and on convection transmission of heat. If cells are relatively small, the convection is negligible, and the solid fraction is responsible for up to 20% of the losses. Because the cell gases substantially contribute to heat loss, the characteristics of blowing agents used in manufacturing become crucial.

During the process of foaming, some carbon dioxide (CO₂) normally enters the cells along with the blowing agent, but it escapes through the cell walls very rapidly compared with other gases. After some time, closed cells contain mainly blowing agents that have very low thermal conductivity. After further time has elapsed, some air may diffuse into the foam, but this has little influence on the insulation properties.

In metal-faced sandwich panels, the core is protected with diffusion-tight skins and the cell gases can only enter or leave through the panel edges.

Previously, the gas that was used as the blowing agent was trichlorofluoromethane (R-11 or CFC-11). However, CFC gases (chlorofluorocarbons) are now banned by the Montreal Protocol because of their ozone depletion potential. There is now a range of blowing agents for use in sandwich panel manufacture, including hydrochlorofluorocarbons (HCFC-22 or R2-2, HCFC-142b or R-142b, HCFC-141b or R-141b), hydrofluorocarbons (HFC, such as R-134a), and various forms of pentane and water that produces carbon dioxide (CO₂) when reacting with isocyanate.

After mixing the constituent chemicals, the liquid foams starts to expand rapidly. The time from the first mixing of the components to the time when the foam core becomes hard is between three and six minutes depending on the thickness of the core. Because the chemical reaction is exothermic, the core materials of panels thicker than 100 mm may reach temperatures in excess of 150°C. It is therefore necessary to store panels with 100 mm or more thickness for at least 24 hours in order to complete the hardening and cooling process before shipping them

to construction site.

1.4 WHAT IS THE DIFFERENCE BETWEEN PUR AND PIR PANELS?

Polyisocyanurate (PIR) foam is a type of rigid polyurethane foam. It has improved fire resistance and differs from pure polyurethane foams only in the ratio in which the primary components, polyol and isocyanate, are mixed. This ratio is approximately 100:150 for PIR and about 100:110 for simple polyurethane. There is, therefore, more isocyanate in PIR panels than in PUR panels. Mechanical properties of the foam may also depend on the activators used.

Sandwich panels with PUR Classic insulation are mainly applied in cold and deep freeze rooms. Sometimes, PUR panels are used for construction of warehouses in seismic zones: they can be fastened with cam locks for additional strength.

PIR panel are much more popular. With PIR Premier panels, you can build:

- cold and deep-freeze rooms
- fruit and vegetable storages
- agricultural buildings, such as cow sheds, poultry houses, pig houses etc.
- logistics centers and refrigerated warehouses
- manufacturing facilities and shops
- office buildings
- service stations and hangars

PIR Premier panels with the customized PIR blend made from the best world components, the best-selling blend in Russia, are also used to renovate constructions built from other materials and to improve their energy efficiency. PIR cores are less combustible compared to PUR. In high temperatures, a porous carbon external layer forms and protects deeper layers from burning. According to the Technical regulations for fire safety requirements (Russian Federal Law FZ-123), sandwich panels with EI 30 fire resistance class and G1 combustibility class are permitted for use as a building or insulation material in industrial and residential construction.

According to TU 5284-006-77983254 and TU 5284-003-77983254 Russian technical requirements, PIR and PUR sandwich panels can be used in outside temperatures up to +80°C. Both types of panels are resistant to moisture and vapor.

PIR panels gained popularity due to their thermal stability and fire resistance. PIR-modified polyurethane polymers are now replacing currently replace all other types of PUR foams as a core material for sandwich panels. Characteristics of cores manufactured on continuous production lines may vary depending on the panel thickness. Components of the mixture should be selected in a way to make the foam quickly rise to the upper face. This means that the density of the foam is somewhat higher closer to the faces than at the mid-height of the panel, where the expansion has been free. Because the line is continuously moving, the cells are usually egg-shaped and orientated in the direction of foaming. Therefore, continuous lines produce panels with manufacturer-specific core structure and features.

Table 1 shows important characteristics of blowing agents currently used for the production of rigid PU foams. Under stress, the polyurethane rigid foam structure collapses when the cell walls buckle and fracture (in compression or shear) or break (in tension). The average density that is normally used is in the range 35—50 kg/m³. Experiments demonstrated that a smaller average cell size leads to lesser thermal conductivity in specimens of PU foam with the same density. On the other hand, higher density means higher panel strength.

Table 1.
Physical and chemical properties of selected blowing agents

Name	Gross formula	Molar mass, g/mol	Thermal conductivity at 25 °C, mW/m·K	Boiling point, °C	Saturated vapor pressure at 20 °C, Bar	Combustion limit, %
R-11	C-Cl ₃ F	137.5	7.8	24	0.88	n/a
R-141b	CH ₃ C-Cl ₂ F	116.9	9.8	32	0.69	5.6-17.6
R-134a	CH ₂ FCF ₃	102.0	14.3	26	5.62	n/a
R-245fa	CHF ₂ CH ₂ CF ₃	134.0	12.2	15	1.24	n/a
R-365mfc	CH ₃ CF ₂ CH ₂ CF ₃	148.0	10.6	40	0.47	3.5-9.0

i-Pentane	C5H12	72.0	14.6	36	0.65	1.4-8.3
Isopentane	C5H12	72.0	13.8	28	0.80	1.4-7.6
Cyclopentane	C5H10	70.0	12.6	50	0.34	1.4-7.8
Carbon dioxide	CO2	44.0	16.3	-78	56.55	n/a
Air	N2O2	28.8	26.5	-193	624.03	n/a

This means that a lower density translates into more effective insulation, but such foams are rather fragile. The figures below show the empirical relationship between thermal conductivity and density of PU foams.

Figure 4.
Relationship between thermal conductivity and average cell size in PU foams

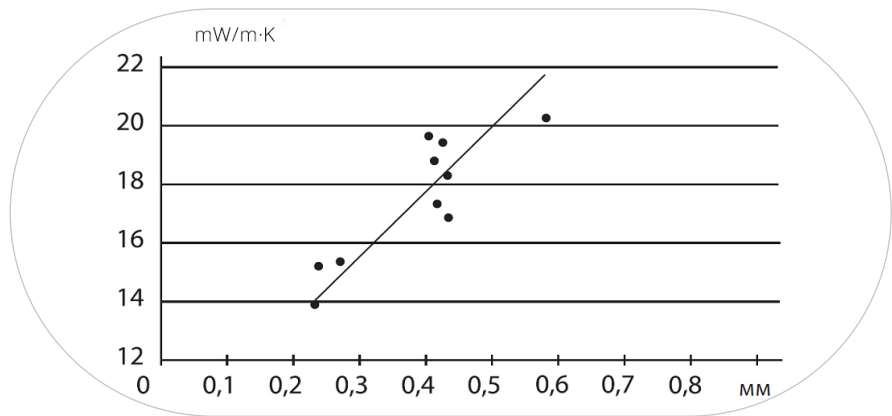
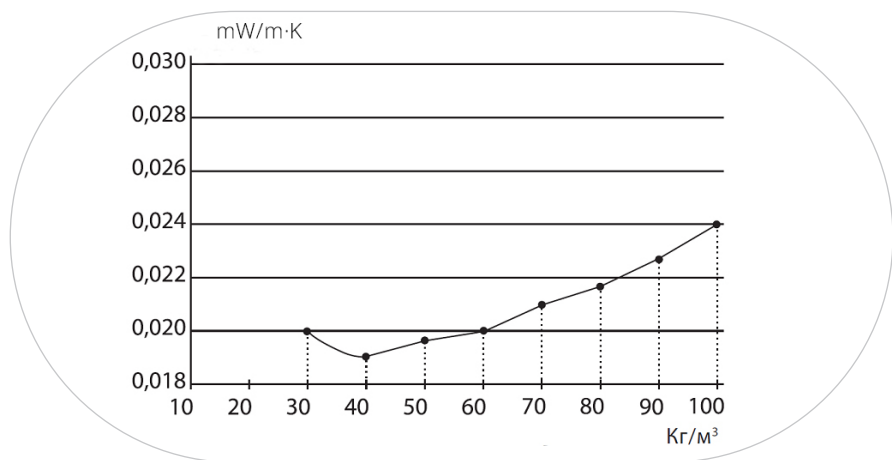

Figure 5.
Relationship between thermal conductivity and density in PU foams



These data suggest that a PU foam with the density of 40 kg/m³ is the best option for thermal insulation. As we will soon show, the rigidity of panels with this core density is also sufficient.

Below are the results of tests of rigid PU foam that are regularly conducted in the research center of Dow Izolan.

Table 2.
Results of tests of PUR specimens (component A is Voracor CD 443, component B is Voracor CD 345)

Parameter	Edge with deformation	Edge without visible deformations	Applicable standard
Apparent core density, kg/m ³	39.4	37.8	GOST 409
Compression strain at 10% deformation, kPa	158.3	208.8	GOST 17177-87

Bending stress at failure, kPa		330	330	GOST 18564
Bending deflection at failure, mm		13.2	13.2	GOST 18564
Water absorption after 24 h, %		1.6	1.6	GOST 23486-79
Bond to faces at uniform separation, kPa	Upper	117.4	117.4	GOST 23486-79
	Lower	207.4	207.4	
Thermal conductivity, W/m·K		0.022	0.022	GOST 7076-99
Dimensional stability at +75 °C after 24 h, %	ΔL			GOST 20989-75
	ΔB	<1	<1	
	ΔH			

Table 3.
Results of tests of a fragment of PIR panel (component A is Voraterm CN815, no primer)

Parameter		Tongue	Center	Groove	Applicable standard
Density, kg/m ³		40.8	41.2	40.9	GOST 409
Apparent core density, kg/m ³		39.5	39.4	39.2	GOST 409
Compression stress at 10% deformation, kPa	Height	116.17	99.97	115.25	GOST 23206-78
	Length	318.87	317.48	317.53	
	Width	125.41	125.25	119.88	
Water absorption in 24 h, %			1.50		GOST 20869-75
Bond to faces at uniform separation, kPa	Upper	134.39	110.77	132.16	GOST 22695-77
	Lower	118.12	111.54	100.32	
Thermal conductivity, W/m·K 10/35			0.22		GOST 22695-77

1.5 WHY IS PIR PREMIER BETTER THAN OTHER PIR SYSTEMS?

While most Russian manufacturers of PU sandwich panels prefer ready-made solutions offered by a handful of multinational corporations, PH Insulation uses PIR Premier, which was developed especially for PH Insulation production lines. For more than three years, this customized blend guarantees the quality of PH Insulation panels and PIR Plita® boards, particularly their thermal conductivity, physical, and mechanical properties.

To create PIR Premier, in 2016 PH Insulation partnered with Dow, BASF, and Evonik international corporations. The blend is certified according to EN 14509 standard. All PIR panels by PH Insulation have been certified with a CE marking symbol since 2017.

As of May 2019, PH Insulation had made more than 5 million square meters of sandwich panels with PIR Premier and over 5 thousand tons of polyol systems.

Currently PH Insulation manufactures panels and doors with PU insulation for more than two thousand companies annually in 15 countries around the world.

WHAT IS THE SECRET OF PIR PREMIER PANELS?

PIR Premier blend is manufactured with attention to all the special features of Pu.Ma continuous lines (Italy) installed at PH Insulation. Immediate integration with further production processes makes the system unique.

In order to guarantee the quality of sandwich panels and PIR Plita® boards, all components are carefully selected by the PH Insulation R&D Center, established in 2016.

The R&D Center assesses 36 physical and mechanical parameters of the blend for better spreading capacity, low thermal conductivity, and other properties of the foam. PH Insulation performs tests for water absorption, dimensional stability, and weight loss in accordance with Russian standards (GOST) for cellular plastics.

In order to better control the quality of polyester, which is one of the crucial elements of the system, PH Insulation negotiated with ten suppliers of reagents worldwide and established contracts with companies that provide solutions for BASF, Dow, Huntsman, Coim, Evonik, Covestro.

Before implementation, PH Insulation conducted about a hundred tests of nine activators from five international manufacturers and found an optimal ratio of activator, pressure, chemical components, and the speed of molds in production lines.

PH Insulation Research Center monitors fourteen parameters of composition and characteristics of sandwich panels in real time, so we can vouch for every square meter of panels in every shipment.

The R&D Center collects and analyzes over 4 Gb of data from our continuous production lines daily. This helps PH Insulation to improve the properties of our panels and find optimal technological modes for each panel thickness. According to EN 14509 standard, the Research Center of PH Insulation conducts both destruction tests for tensile strength, compression strength, modulus of the core, and bending deflection; and non-destructive tests for artificial aging and thermal conductivity.

Every week, PH Insulation cuts, tears, compresses, bends, burns, heats to over 100°C and more, sinks, and freezes in a special chamber up to 50 meters of specimens of panels from its assembly lines.

As a result of this effort, PIR Premier panels with a core density of 40 kg/m³ resist compression of over 185 kPa with 10% deformation, and demonstrate a shear strength of 160 kPa or more.

PH Insulation is committed to thoroughly testing our components or technological adjustments. Currently PH Insulation controls the quality of PIR system on the molecular level. In 2020, PH Insulation installed a reactor for manufacturing complex polyethers by H&S Anlagentechnik, Germany. Currently it is the most advanced equipment worldwide.

1.6 METAL FACINGS

Metal faces on panels manufactured by PH Insulation comply with the standards listed in Table 4.

Table 4.
Standards for metal faces of PU sandwich panels

Type	Minimum yield strength	GOST
Zinc coating	220 MPa	GOST 14918-80 GOST P 52246-2016
Zinc and organic coating	220 MPa	GOST 30246-2016 GOST P 52146-2003 GOST P 54301-2011
Stainless steel	220 MPa	GOST 19904-90, EN 10088-1:2005
AMr2 1/2H aluminum alloy	140 MPa	GOST 21631-76

Metal faces (with the exception of stainless steel) are usually made of rolled steel (GOST 14918-80, Group B, first class of coating) or imported thin steel sheets with a zinc (Zn) or zinc-5% aluminum (Zn-5%Al) corrosion protection layer, or coatings based on aluminum, zinc, and silicon (Zn-55%Al).

For some types of constructions and for additional durability, organic or complex protective coatings may be used. Type and thickness of faces are always indicated for every shipment. PH Insulation offers panels with metal faces from 0.35 mm to 0.7 mm thick.

The minimum yield strength of stainless faces is shown in Table 5. The chemical composition of faces and their physical properties meet the requirements of GOST 5632-14 standard. PH Insulation uses steel sheets and rolls (GOST 19904-90) or similar imported products (AISI 304 for the food industry, and AISI 430 for general purposes).

Table 5.
Technical characteristics of metal facings of panels

Minimum yield strength	280 MPa
Maximum yield strength	320 MPa
Ultimate tensile strength	360 MPa
Elongation	0.00%
Total weight of zinc coating on both faces	> 275 g/m ²
Average thickness of zinc coating	≥ 20 μm
Standard width of steel sheet	1250 mm
Average thickness of polyester coating (for painted faces)	25–30 μm

1.7 PRODUCTION LINES

Sandwich panels are manufactured using continuous production lines or discontinuous assembly line when the foaming mixture is sprayed into a closed mold with the dimensions of the required panel.

DISCONTINUOUS LINE

In this type of production, the lower facing is laid on the bottom of the mold and the upper facing is placed in position supported on spacers. The resulting structure is very robust and can resist the pressures that arise during foaming. Small openings at the ends of the mold release air and excessive foam. This allows the foam to distribute in a uniform manner.

The mixture is sprayed into the cavity through a nozzle introduced through the side of the mold. The operation takes only a few seconds. After foaming, the panel is left in the mold under pressure from 15 to 50 minutes depending on its thickness. Then it may be removed and the mold prepared for the next panel. Using this method, panels of various shapes with different facings can be produced. The disadvantage is that the process is relatively slow. Even if a team of operatives work in cycles on several molds, and up to two panels are made simultaneously in each mold, the efficiency is not high.

CONTINUOUS LINES

For mass production, continuous automatic lines are used. Such a line can produce approximately 500,000 square meters of sandwich panels in a single shift at an average speed of 15 meters per minute. This production rate does not affect the quality of the panels.

Faces are made of two coils of metal. Static electricity is neutralized using a corona discharge method to improve adhesion of faces to the PU core. Most production lines are equipped with antistatic devices offered by just one Italian manufacturer.

After that, the panels pass through roll formers, where the surface profile and edge details are formed, including locking systems. Any deviations from the design parameters of locking systems are specified in technical documentation and are usually the same for all manufacturers around the world. Both sides of the steel sheet are usually coated first with a primer (a layer of glue) that provides a good bond between the foam and the facings, and then the panel is heated to the required temperature, which is a prerequisite for an optimal chemical reaction. The two-component foam mixture is then introduced between two sheets, and the strips enter a double conveyor, which keeps the faces apart at the required distance. The sides of the panel are likewise formed by lateral formers that are similar to small chain belts. When the continuous panel emerges, the foam may be cut to the required lengths by a flying saw. Because of noise, the cutting is always performed in a separate room. The panels are then cooled down, stacked, packed for delivery, and covered with protective foil.

The foam continues to form for about 24 hours after it exits the line, therefore sandwich panels should be stored

in a controlled temperature. This, as well as all the previous stages, is very important for the correct shape of panels. Production lines are always assembled individually according to client's requirements, so if you are told that a certain line is unique and customized, take such claims with a grain of salt.

Image 2.
A section of continuous line by Pu.Ma, Italy, installed in PH Insulation manufacturing facility.



CHAPTER 2: PARAMETERS AND FEATURES OF SANDWICH PANELS

2.1 DIMENSIONAL TOLERANCES

Table 6.
Dimensional tolerances of sandwich panels

Parameter	Diagram	Tolerance
Thickness of panel		for $D \leq 100$ mm: 2 mm for $D > 100$ mm: $\pm 2\%$
Deviation from flatness for measured distance on flat plane (L)		for $L = 200$ mm: 0.6 mm for $L = 400$ mm: 1.0 mm for $L > 700$ mm: 1.5 mm
Depth of metal profile ribs (roof panels)		$h = \frac{h_1 + h_2}{2}$ $h = (40 \pm 1) \text{ mm}$
Depth of stiffeners on lightly profiled facings (wall panels)		$(1.5 \pm 0,3) \text{ mm}$

Length

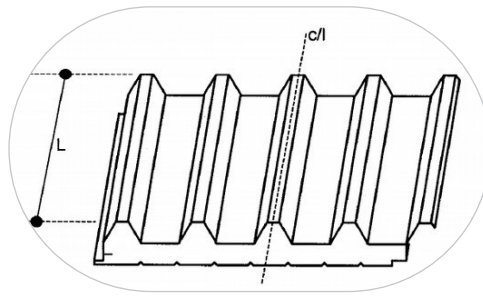

for $L \leq 3$ m: ± 5 mm
for $L > 3$ m: ± 10 mm

Cover width

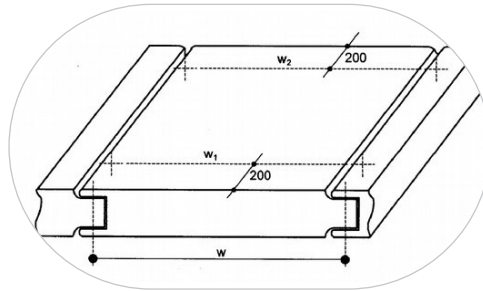

± 2 mm

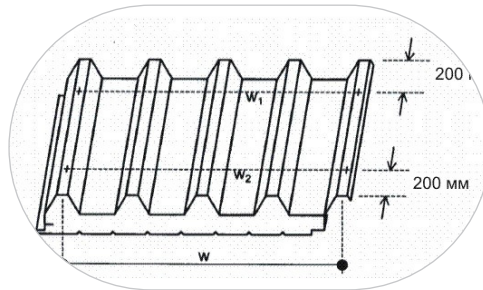

Deviation from squareness

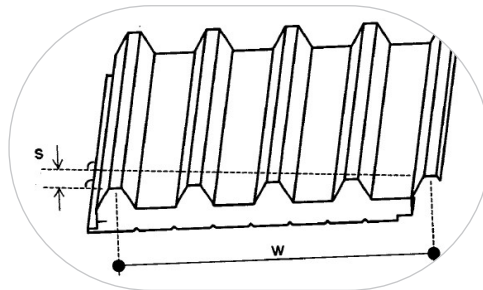

0.6% of the nominal cover width

Deviation from straightness

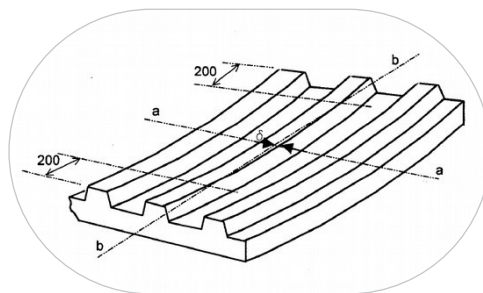

1.0 mm/m, not exceeding 5 mm

Bowing

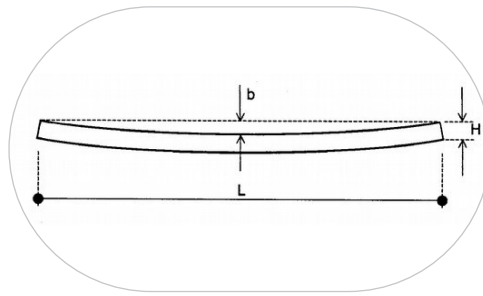

2.0 mm for each meter length but not greater than 10 mm;
8.5 mm for each meter width for lightly profiled wall panels;
10 mm for each meter width for roof panels

Pitch of profile (roof panels)

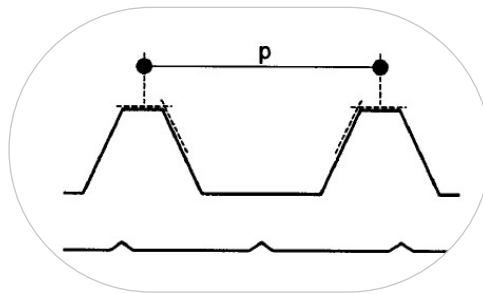

$p = (250 \pm 2) \text{ mm}$

Widths of rib (b_1) and valley (b_2)

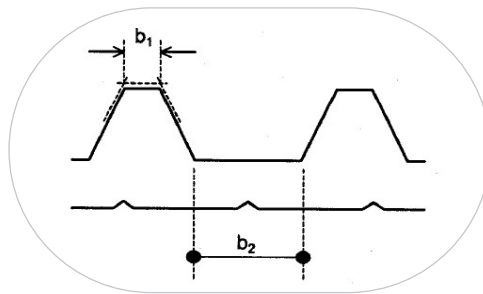

$b_1: \pm 1 \text{ mm}$
 $b_2: \pm 2 \text{ mm}$

2.2 THERMAL CONDUCTIVITY, THERMAL TRANSMISSION, AND THERMAL RESISTANCE OF PU PANELS

Thermal losses in buildings and other structures occur due to:

1. Transmission losses through floors, walls and ceilings; and
2. Ventilation losses as a consequence of permeable cladding (natural ventilation).

Transmission losses can be reduced by using materials with lower thermal conductivity. Ventilation losses can be decreased by an efficient ventilation system and by providing a 'tight' build.

Sandwich panels are a good solution to prevent thermal losses in both ways. The thickness of thermal insulation depends on purposes and climate conditions.

Let's look at physical principles that define the insulation properties of various materials and structures.

One of them is thermal transmission (not to be confused with thermal conductivity), which occurs when particles of substance (molecules, atoms, and electrons) transfer heat in the course of their motion. The temperature of an object depends on kinetic energy of its atoms and molecules, and this energy goes from more to less warm parts, or to another interacting object, for this purpose. The process occurs in any object with unequal distribution of temperature, but its mechanism is influenced by physical state.

The steady flow of energy through a wall of surface area S is directly proportional to the temperature difference between its sides, and is inversely proportional to its thickness. In case of heat flow through a wall made from sandwich panels, heat losses between the faces are given by:

$$Q = -\lambda \frac{S\Delta T}{\delta} \quad (1)$$

where Q = rate of thermal losses, S = surface area, ΔT = temperature difference across the panel, and δ = thickness of insulation.

Thermal conductivity λ is measured in $\text{W/m}\cdot\text{K}$ and quantitatively describes the ability of a material to conduct heat. It should be noted that this is a physical feature of the material that depends exclusively on its internal structure,

and not on the shape or dimensions.

Table 7.
Thermal conductivity of the most popular materials

Material	$\lambda_{\text{declared}}$ W/m·K
Aluminum	202–236
Steel	47–60
Glass	1,15
Brick	0,87
Concrete	1,7
Foam concrete	0,14–0,30
Wood	0,15
Mineral wool	0,046
Expanded polystyrene	0,04
Urea formaldehyde foam	0,035
Air (dry and still)	0,024–0,031
Polyurethane foam (PUR/PIR)	0,021–0,023

Usually, the declared thermal conductivity of both PUR and PIR foams is in the range of 0.021–0.022 W/m·K. According to EN 14509-2005 standard, the manufacturer must declare lambda 90/90 values that ensure that the declared thermal conductivity can be obtained for 90% of production within a 90% confidence level. Thermal conductivity (λ_{design}) is actually a more important for construction purposes than declared thermal conductivity. What is the difference?

As previously mentioned, EN 14905-2005 standard for sandwich panels clearly and comprehensively describes the procedures for measurement of all important parameters, including design thermal conductivity. It considers a range of core materials, which may significantly differ in respect of durability.

According to EN 14509 and EN 13165-2008, design thermal conductivity of rigid PU foams is adjusted for aging; the escape of the blowing agent from cells and its replacement by air is the main factor in the aging of PU foams.

The influence of humidity on thermal conductivity of panels is not taken into account, because the external face ensures that moisture does not penetrate the foam, if the panels are installed properly.

Thermal conductivity actually depends on humidity, but this is only of importance if sandwich panels are poorly installed. In this case, moisture penetrates the core through unsealed joints and the core is exposed to environmental conditions.

Periodic and seasonal humidity changes do not affect the structure of PU foam and do not contribute to its aging. For mineral wools, on the other hand, high humidity is a degrading factor.

Thermal conductivity also depends on environmental temperatures, but EN 14509-2005 and Russian GOST 54855-2011 do not require samples to be heated in order to determine their design thermal conductivity. Insulation properties of PU foam deteriorate first of all due to the diffusion of the blowing agent and its replacement by air, and humidity is a minor factor to be considered only under certain conditions.

Different approaches to the definition of design thermal conductivity in Russia and EU are summarized in Tables 8 and 9.

Table 8.

Declared and design thermal conductivity of sandwich panels according to EN 14509-2008

Parameter	Declared thermal conductivity	Design thermal conductivity*	Main aging factor
Thermal conductivity	90/90 λ declared values for dry specimens at average temperature 10°C, no aging	90/90 λ declared values for dry specimens at average temperature 10°C, after aging *	Replacement of blowing agent by air

* Aging procedure depends on the type of blowing agent. Design thermal conductivity for all types of panels with tight metal faces is indicated with an increment of 0.001 W/m·K (see EN 13165-2008)

Table 9.

Declared and design thermal conductivity of building materials according to Russian SNiP 23-02-2003

Parameter	Thermal conductivity	Conditions A	Conditions B
Thermal conductivity	Average thermal conductivity of at least five dry specimens (according to GOST 7076-78)	Thermal conductivity for 2% moisture sorption	Thermal conductivity for 5% moisture sorption

2.3 CALCULATION OF THERMAL TRANSMITTANCE AND THERMAL RESISTANCE

Along with thermal conductivity, thermal transmittance (U) and thermal resistance (R) define insulation properties of floors, ceilings, roofs etc., including those made from sandwich panels. In terms of thermal transmittance, the flow of heat through a sandwich panel is calculated as follows:

$$Q = US\Delta T \quad (2)$$

where U = measured thermal transmittance of the sandwich panel in W/(m²·K), which depends on its thickness; S = surface area of the wall in m²; and ΔT = the difference between air temperatures on both sides of the panel.

Thermal resistance characterizes the ability of an object, surface, or layer to impede the motion of molecules. Total thermal resistance, which is inverse to thermal transmittance, is distinguished from surface thermal resistance, which is inverse to heat losses, and from layer thermal resistance, which is equal to the ratio of thickness of the layer and its thermal conductivity.

More generally, thermal transmittance (U) is defined as

$$U = \frac{1}{R_{si} + \frac{t_{ni}}{\lambda_{fi}} + \frac{(d_c + \Delta e)}{\lambda_{design}} + \frac{t_{ne}}{\lambda_{fe}} + R_{se}} + \frac{\Psi}{B} \quad (3)$$

where

d_c = nominal thickness of the core (ignoring the thickness of the facings), m

t_{ni} = nominal thickness of the internal facing, m

t_{ne} = nominal thickness of the external facing, m

λ_{design} = design thermal conductivity of core, W/m·K

λ_{fi} = declared thermal conductivity of the internal facing, W/m·K

λ_{fe} = declared thermal conductivity of the external facing, W/m·K

Δ_e = additional thickness due to the profiles of both faces, m

Ψ = linear thermal transmittance of the joints per meter length of panel, W/m·K

B = overall width of the panel, m

R_{si} = internal surface resistance, m²·K/W

R_{se} = external surface resistance, m²·K/W

The internal surface resistance (Rsi) and the external surface resistance (Rse) shall be determined according to EN ISO 6946 and are shown in the table below.

Table 10.
Heat Direction

	Direction of heat flow		
	Roof	Walls	Floor
Internal surface resistance (R_{si}), m ² ·K/W	0,10	0,13	0,17
External surface resistance (R_{se}) m ² ·K/W	0,04	0,04	0,04

Additional thickness Δe is important for roof panels and depends on geometry and the height of profiles.

Figure 6.
Calculation of Δe for PH Insulation panels according to EN 14509-2008; $b_1 = 20$ mm, $b_2 = 60$ mm, $h = 40$ mm, $p = 250$ mm.

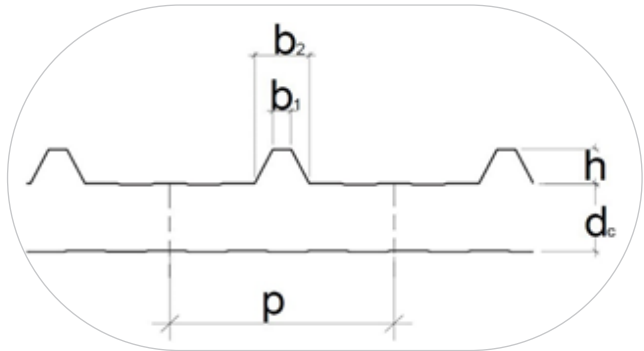

Table 11.
Calculation of Δe for roof panels

	Height of ribs (h), mm			
	$10 \leq h \leq 25$	$25 \leq h \leq 50$	$50 \leq h \leq 70$	$h > 70^*$
$r < 25\%$	1	2	2	2
$25\% < r \leq 50\%$	3	5	6	7
$50\% < r \leq 60\%$	5	9	12	14
$60\% < r \leq 70\%$	7	12	16	19
$70\% < r \leq 85\%$	8	15	20	24

* If $h > 120$ mm, more precise calculations are needed

Here,

$$r = \frac{0,5(b_1 + b_2)}{p} = \frac{16}{100}, \text{ i.e. } 16\% \quad (4)$$

Therefore, $\Delta e = 2$ mm for roof panels manufactured by PH Insulation.

Alternatively, the formula (4) can be represented as:

$$U = \frac{1}{R_s + \frac{t_h}{\lambda_f} + \frac{d_c + \Delta e}{\lambda_{design}} + \frac{t_b}{\lambda_{\xi}} + R_{\xi}} \left(1 + f_{p, int} \frac{1,0}{B} \right) \quad (5)$$

where f_{joint} is thermal transmittance of joints per meter of length of the panel (see Table 12).

Table 12.
Thermal transmittance of joints (f_{joint}) for steel faces

Thickness, mm	f _{joint}	
	Roof	Wall
60	0,04	0,20
80	0,04	0,20
120	0,04	0,10
160	0,04	0,10
200	0,03	0,10

Let's calculate, for example, thermal transmittance of a PU wall panel (thickness = 100 mm, width = 1.190 mm, 0.5 mm metal faces):

- external surface: R_{se} = 0.04 m²·K/W
- 0.5 mm face: λ_{fe} = 60 W/m·K
- 100 mm PUR core: λ_{design} = 0.026 W/m·K
- 0.5 mm face: λ_{fi} = 60 W/m·K
- internal surface: R_{si} = 0.13 m²·K/W

From the formula (5):

$$U = \frac{1}{0,04 + \frac{0,5 \cdot 10^{-3}}{60} + \frac{102 \cdot 10^{-3}}{0,026} + \frac{0,5 \cdot 10^{-3}}{60} + 0,13} \cdot \left(1 + 0,1 \cdot \frac{1,0}{1,190} \right) \approx 0,26 \quad (6)$$

2.4 THERMAL INSULATING PROPERTIES OF BUILDING MATERIALS

The concept of thermal resistance helps to illustrate the difference of various materials in respect of thermal insulation properties.

Table 13 shows the thermal conductivity of popular building materials calculated from their declared thermal conductivity. The image on the right shows the layer of these materials with thermal insulation properties equal to that of 100 mm layer of PUR or PIR foam.

Table 13.
Thermal conductivity of popular building materials. Layers on the right have equal insulation properties.

Material	λ, W/m·K	Thickness, mm
PUR/PIR	0,022	100
Expanded polystyrene	0,04	190
Mineral wool	0,046	285
Wood	0,15	714
Expanded clay blocks	0,3	1430
Brick	0,37	1760

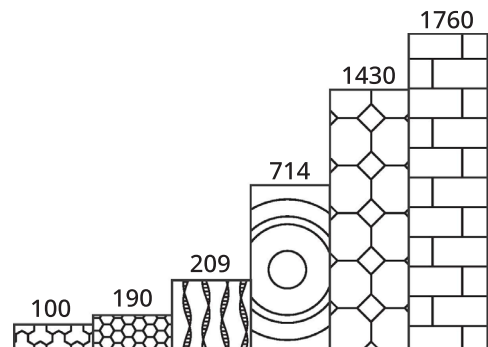

All layers indicated in the table are equally resistant to heat loss (4.76 m²·K/W).

2.5 HEAT CAPACITY

Lightweight sandwich constructions have relatively small capacity to accumulate heat compared to traditional building materials like concrete.

The heat or thermal capacity (C) of a part of a building is defined by the average specific heat capacity of its material expressed in W/kg·K, and its mass (m) in kg:

$$C = mc$$

The table below shows the average specific heat capacity of some building materials.

Table 14.
Specific heat capacity of typical building materials

Material	λ , W/m·K	Thickness, mm
Concrete	2300	900
Light concrete	500	1000
Wood	500	2300
Mineral wool	7800	500
Expanded clay blocks	70–150	1030
PUR, PIR	40–42	1400

Let's compare the heat capacity of 100 mm concrete wall with that of a PUR panel of equal thickness (to simplify the task, we consider the panel to consist of a 100 mm core and 0.5 mm metal faces)

$$100 \text{ mm concrete} \quad C = 2300 \cdot 0.1 \cdot 900 = 207 \times 10^3 \text{ W/K}$$

$$100 \text{ mm PUR sandwich panel} \quad C = 40 \cdot 0.1 \cdot 1400 + 7800 \cdot 0.001 = 5607.8 \approx 5.61 \times 10^3 \text{ W/K}$$

The comparison shows that the heat capacity of concrete is more than 36 times higher than the heat capacity of panels.

Materials with a high heat capacity accumulate a significant amount of heat and should therefore be used for internal walls and floors in modern buildings. On the other hand, materials with good thermal insulation properties are a better option for external walls. In this case, less energy will be needed to maintain a decreased temperature in cold stores or room temperature in offices and residential buildings. If external walls are made from light materials with a low heat capacity, for example sandwich panels, the temperature inside settles much faster.

2.6 THERMAL BRIDGES AND HEAT LOSSES

Thermal bridges are areas that have a lower thermal resistance compared to other parts of a structure. They usually arise during installation of panels, when a material with good thermal conductivity, for example metal, comes into contact with both faces. In addition to heat losses, thermal bridges also increase the risk of condensation precipitation on the external surface.

To prevent this, sandwich panels have special joints and should be installed in accordance with strict guidelines.

Door and window openings are additionally framed with a profile that breaks the bridges.

Steel screws with low thermal conductivity and, if possible, with a low cross-section area and a rubber washer should be used to fasten the panels. The elimination of thermal bridges is a critical task during construction, and the quality of installation determines how effectively the panels do their job in providing thermal insulation.

Table 15.
Main characteristics of PIR and PUR wall panels by PH Insulation

Core	PUR/PIR										
Density	(40 ± 2) kg/m ³										
Panel thickness, mm	40	50	60	80	100	120	140	150	160	180	200
Weight, kg/m ²	8.5–9.5	8.9–9.9	9.7–10.7	10.4–11.6	11.2–12.4	11.9–13.2	12.7–14.1	13.1–14.5	13.5–14.9	14.2–15.8	15–16.6
Maximum length	16 000 mm										
Width	1 200 mm										
Cover width	1 190 mm										
Thickness of metal faces	≥ 0,45 mm										
Type of faces	Profiled / Flat										
Standard coating	RAL 9003 / Zn (unpainted zinc coating)										
Thermal conductivity	0.021 W/m·K										

Thermal resistance	1.90	2.38	2.86	3.81	4.76	5.71	6.67	7.14	7.62	8.57	9.52
Water absorption after 24 h, 96% relative humidity	12,5%										
Water absorption after 24 h, full immersion, percent of volume	2,5%										
Sound insulation	25 dB										

Table 16.
Main characteristics of PIR Premier roof panels by PH Insulation

Core	PIR Premier										
Density	(41 ± 2) kg/m ³										
Panel thickness, mm	40	60	80	100	120	150					
Weight, kg/m ²	9.8	10.7	11.5	12.3	13.1	14.4					
Maximum length	16 000 mm										
Width	1 071 mm										
Cover width	1 000 mm										
Thickness of metal faces	≥ 0,45 mm										
Type of faces	Profiled / Flat										
Standard coating	RAL 9003/Zn (unpainted zinc coating)										
Thermal conductivity	0.021 W/m·K										
Thermal resistance	2.0	2.95	3.90	4.86	5.81	7.24					
Water absorption after 24 h, 96% relative humidity	1—2,5%										
Water absorption after 24 h, full immersion, percent of volume	2,5%										
Sound insulation	35 dB										

Table 17.
Fire resistance of PUR/PIR wall and roof panels

Parameter	Product	40 mm	60 mm	80—120 mm	150—200 mm
Fire resistance	PUR wall panels	EI 15			
	PIR wall panels	EI 15	EI 30	EI 45	
	PIR roof panels	RE 15	RE 15	RE 30	RE 30
Fire hazard	PIR roof panels	K1 (15)			
Combustibility	G2				
Flammability	V1				
Smoke emission	PIR wall panels	D3			
Toxicity of combustion products		T2			
Flame spread		RP1			

2.7 COLOR

Panel colors are classified into three groups based on their thermal energy absorption ratio, see Table 6.

Light colors reflect sun's energy better and absorb less heat.

In accordance with the European standard for sandwich panels with metal cladding EN 14509, the temperature T of the outer cladding has a maximum value typical for the summer period. This figure depends on the color and the light reflectance value of its surface. T-values are the minimum values for calculating thermal deformation of insulated panels.

Table 18.
Thermal energy absorption ratio of RAL colors

Group I Intensely light colors	Group II Light colors			Group III Dark colors		
1013	1000	1001	1002	2002	2013	3000
1015	1003	1004	1005	3002	3003	3004
1016	1006	1007	1011	3005	3007	3009
1018	1012	1014	1017	3011	3013	3020
1026	1019	1020	1021	3032	4004	4007
6019	1023	1024	1027	5000	5001	5002
7047	1028	1032	1033	5003	5004	5005
9001	1034	1035	1036	5007	5008	5009
9003	1037	2000	2001	5010	5011	5013
9010	2003	2004	2005	5014	5022	5026
9016	2007	2008	2009	6000	6001	6002
	2010	2011	2012	6003	6004	6005
	3001	3012	3014	6006	6007	6008
	3015	3016	3017	6009	6010	6011
	3018	3022	3024	6012	6014	6015
	3026	3027	3031	6020	6022	6029
	3033	4001	4002	7000	7012	7015
	4003	4005	4006	7016	7021	7022
	4008	4009	4010	7024	7026	8004
	4011	4012	5012	8011	8012	8014
	5015	5018	5021	8015	8016	8017
	5024	5025	6013	8019	8022	8023
	6016	6017	9018	8025	8028	
	6021	6024	6025	9005	9007	
	6027	6032	6033			
	6034	6035	6036			
	7001	7002	7003			
	7004	7005	7006			
	7008	7009	7010			
	7011	7013	7023			
	7030	7031	7032			
	7033	7034	7035			
	7036	7037	7038			
	7039	7040	7042			
	7043	7044	7046			
	7048	7075	8000			
	8001	8002	8003			
	8007	8008	8024			
	8029	9002	9006			
	9022					

CHAPTER 3: EXTERNAL LOAD ON PANELS

3.1 DEFORMATIONS DUE TO SURFACE TEMPERATURE DIFFERENCE

Light absorption, which depends on the color of external faces, may lead to excessive heating and result in deformations of panels. This problem can arise in any conditions, if the temperature across the panel differs significantly. These thermal deformations are characterized by the linear thermal expansion of metal (αL):

$$\Delta L = \alpha L \cdot L \cdot \Delta T \quad (7)$$

where L = length or width of the panel, ΔL = thermal expansion, and ΔT = temperature difference.

Depending on the material, αL of metal faces varies from 11×10^{-6} to 13×10^{-6} ($1/^\circ\text{C}$). This value is almost unaffected by temperature fluctuations. Whenever the temperatures across the panel differ, it will experience deformations.

The deflection at the center of panel with the length L is:

$$\Delta X = \frac{\theta L^2}{8} \quad (8)$$

where $\theta = (\alpha_2 T_2 - \alpha_1 T_1)/D$, D = distance between the centers of metal faces, and T_1 and T_2 = temperature of faces.

The deflection of a panel of thickness d covered with metal faces of the same thickness δ is as follows:

$$\Delta X = \frac{\alpha_L \Delta T \cdot L^2}{8(d - \delta)} \quad (9)$$

Table 19 shows the values of deflection for 3 and 6 m panels, if temperature difference between internal and external faces is 55°C .

Table 19.

Thermal deformation of panels with the length of 4 m and 6 m and temperature difference of 55°C between faces

Panel thickness, mm	Thermal deformation if $\Delta T = 55^\circ\text{C}$, cm	
	L = 3 m	L = 6 m
40	1.86	7.43
50	1.49	5.94
60	1.24	4.95
80	0.93	3.71
100	0.74	2.97
120	0.62	2.48
150	0.50	1.98
200	0.37	1.49

The table suggests that if external faces that experience strong heating are painted with dark colors (Groups II and III), it is better to install panels in shorter spans.

3.2 MECHANICAL RESISTANCE OF WALL PANELS

Unlike traditional insulation materials that only retain heat, sandwich panels are self-supporting and may be used for construction of small buildings, for instance, cold storages.

Obviously, a sandwich panel as a whole is much more resistant than its two thin metal faces or a layer of rigid polyurethane foam inside. The bending stiffness of the faces if taken separately is so insignificant that they hardly bear their own weight, and the polyurethane quite easily deforms because its elastic modulus as well as extensional and compression strength are low. However, together they form a structure with high mechanical resistance because the load is shared by all its layers. The faces resist the bending moment, whereas the core resists the shear stress.

Therefore, shear force acts on the core, which is responsible for the load-bearing capacity of the entire three-layer structure (the increase of the shear strength of the core increases the strength of the panel). In profiled panels, the bending stiffness of faces also participates in the distribution of the load. In this case, both the faces and the entire panel resist bending moment and shear force: compression force acts on the upper face, extension force acts on the lower face, and shear force acts on the PU foam core. To make the core resist shear force and support the faces, a strong adhesion bond between the layers of the panel is necessary.

Mechanical resistance of sandwich panels is usually described by an augmented beam theory which takes into account the shear flexibility of the core.

Let's consider a beam in the form of a sandwich panel with metal faces of equal thickness δ and a PU foam core between them of thickness $d - 2\delta$ and length L (Figure 7).

First, let's define the bending stiffness of the panel D . If bending stiffness of a standard beam is a product of its elastic modulus and moment of inertia (I), then bending stiffness of a sandwich panel is a sum of the stiffnesses of all its separate layers calculated along the central axis:

$$D = \frac{E_F b \delta^3}{6} + \frac{E_F b \delta \cdot (d - \delta)^2}{2} + \frac{E_C b (d/2 - \delta)^3}{12} \quad (10)$$

where E_F and E_C = elastic moduli of the faces and the core, respectively; other parameters are explained in Figure 7.

Figure 7.
Sandwich panel as a beam

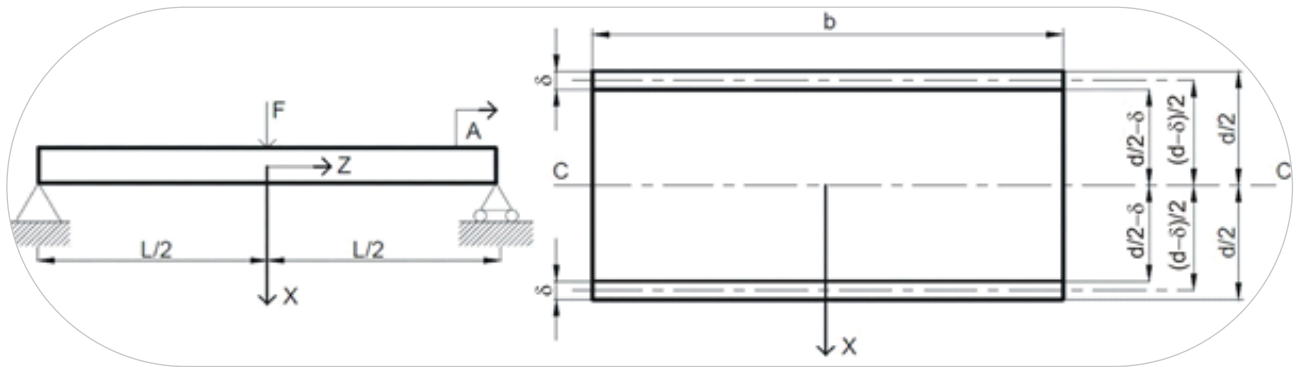

The first component in the formula (10) is the bending stiffness of faces along their central axes; the second component is the bending stiffness of faces along the central axis of the panel, and the third component is the stiffness of the polyurethane core along its axis, which is generally the central axis of the panel. The first component is less than 1% of the second, if the following condition is fulfilled:

$$\frac{d}{\delta} > 6,7 \Rightarrow \frac{E_F \delta \cdot (d - \delta)^2}{E_C (d/2 - \delta)^3} > 16,7 \quad (11)$$

If condition (11) is true, the formula (10) can be represented as:

$$D = \frac{E_F b \delta \cdot (d - \delta)^2}{2} + \frac{E_C b (d/2 - \delta)^3}{12} \quad (12)$$

$d/\delta = 80 > 6.7$ even for the thinnest panels of 40 mm width, so (12) is true. Because the thickness of the faces is much less than the entire panel ($\delta/d \ll 1$), the first component in the formula (10) is negligible compared to the two others.

The second component in formula (12) is less than 1% of the first component, if

$$\frac{E_F \delta \cdot (d - \delta)^2}{E_C (d/2 - \delta)^3} > 16,7 \quad (13)$$

Stresses that arise in a loaded panel may also be described by classical beam theory with some assumptions. When the panel bends, compression forces act on it above the neutral C—C axis, and the extension forces act below this axis.

$$\varepsilon_x = \frac{Mx}{D} \quad (14)$$

where ε_x = extension or compression on the distance x from the neutral C—C axis, M = shear moment, D = bending stiffness of the panel.

To calculate the stress that arises when a sandwich panel bends, the deflection (14) is multiplied by elastic modulus. Because sandwich panels are not homogenous structures, the product of multiplication is indicated for its parts (see Figure 8):

$$\sigma_m = \frac{Mx}{D} E_F \quad \frac{d}{2} - \delta < x < \frac{d}{2} \quad -\frac{d}{2} < x < -\frac{d}{2} + \delta \quad (15)$$

$$\sigma_p = \frac{Mx}{D} E_C \quad -\frac{d}{2} + \delta < x < \frac{d}{2} - \delta \quad (16)$$

where, σ_m = stress in the metal faces, and σ_p = stress in the polyurethane core. The stress is maximal when x reaches maximal values in the following limits:

$$\sigma_m^{\max} = \frac{Md}{2D} E_F \quad \sigma_p^{\max} = \frac{M(d/2 - \delta)}{D} E_C \quad (17)$$

where, σ_m = stress in the faces, and σ_p = stress in the core. The stress is maximal, when x reaches its maximum limit:

$$x = \frac{k_1 E^3}{E_F J_F} + \frac{k_2 E}{G_C S_C} \quad (18)$$

where F = applied force, $E_F J_F$ = product of elastic modulus and moment of inertia (or bending stiffness of the faces), G_C = shear modulus of the polyurethane core, and S = cross-sectional area of the core.

Figure 8.
Bending of a three-layer panel

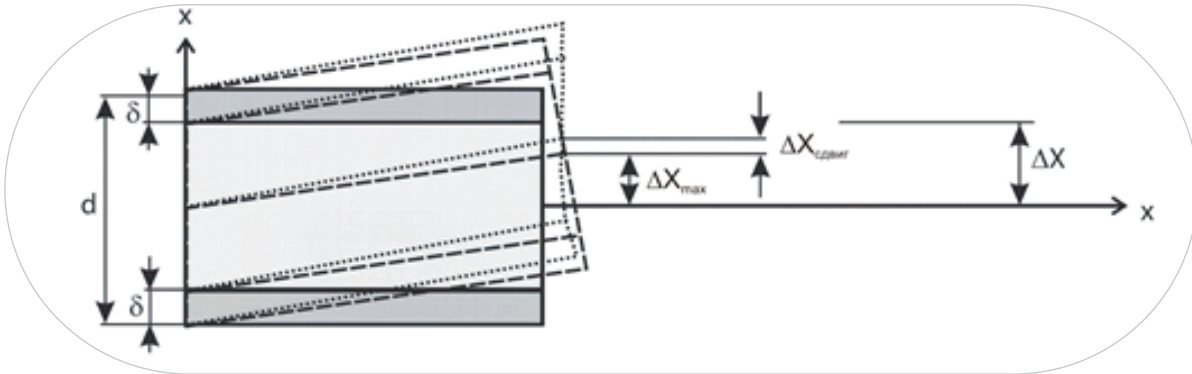
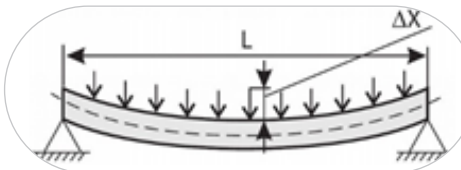
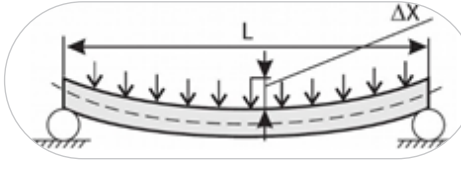
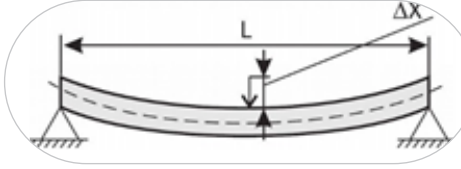
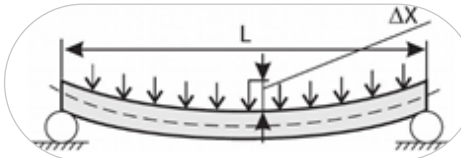

Figure 8 shows total bending and shear deflection of the panel from its normal position. The first component of the equation above is known from the beam theory and determines the bending deflection. The second one is the shear deflection due to the shear of the core. k_1 and k_2 coefficients are shown in the table below and depend on the edges of panel.

Distribution of load	k_1	k_2	Description
	$\frac{1}{384}$	$\frac{1}{8}$	Uniformly distributed load. Fixed edges.
	$\frac{5}{384}$	$\frac{1}{8}$	Uniformly distributed load. Free edges.
	$\frac{1}{192}$	$\frac{1}{4}$	Central load. Fixed edges.
	$\frac{1}{48}$	$\frac{1}{4}$	Central load. Free edges.

For the moment of inertia is J and cross-sectional area of the insulation:

$$S = 119,0(d - 2\delta)$$

where 119,0 = width of the panel in cm, δ = thickness of the faces, d = thickness of the panel. From now on, we will consider non-profiled metal faces; profiled faces have a much higher moment of inertia that depends on the height of profile and additionally stiffens the panel.

One of the most important parameters of elastic properties of sandwich panels is shear modulus of the core, which in this case is made of PU foam. According to EN 14509, it is measured during a bending test with four load points. The width L_s of the load spreading plates shall be 60–100 mm in order to avoid local compression of the faces

Figure 9.
Bending test with four load points

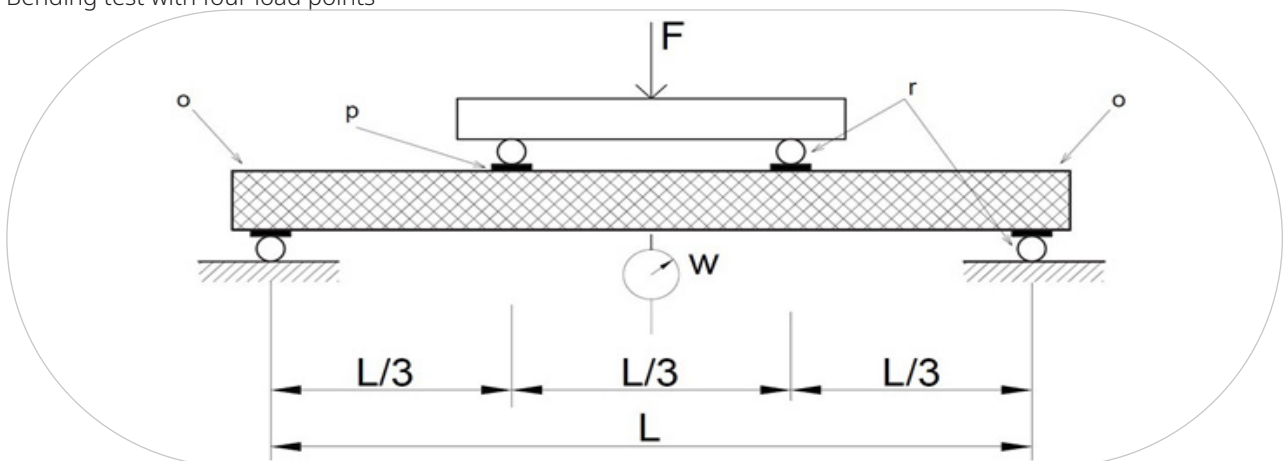

- F = applied load
- r = rollers, radius 15 mm
- w = measured deflection
- p = load spreading plates of thickness 8–12 mm and width L_s
- o = overhang not exceeding 50 mm

Shear modulus of the core (GC) is calculated as following:

$$B_S = \frac{E_{F_1} A_{F_1} E_{F_2} A_{F_2}}{E_{F_1} A_{F_1} + E_{F_2} A_{F_2}} e^2 \quad \text{flexural rigidity (19)}$$

$$\Delta X_B = \frac{\Delta F \cdot L^3}{56,34 B_S} \quad \text{bending deflection (20)}$$

$$\Delta X_S = \Delta X - \Delta X_B \quad \text{shear deflection (21)}$$

$$G_C = \frac{\Delta F \cdot L}{6 b d_c \Delta X_S} \quad \text{shear modulus (22)}$$

where E_{F_1} = elastic modulus of the top face; A_{F_1} = measured cross-sectional area of the top face, A_{F_2} = measured area of cross-section of the bottom face, E_{F_2} = elastic modulus of the bottom face, e = measured depth between the centroids of the faces ($d/2 - \delta/2$), ΔX = deflection at mid-span for a load increment ΔF taken from the slope of the linear part of the load-deflection curve, which reflects the dependence of deformation from load, d_c = the depth of the core material ($d_c = d - (\delta_1 + \delta_2)$), i.e. the thickness of the panel after deduction of the thickness of the two facings, and b = measured width of the specimen.

Tests performed by Dow Chemical Company laboratories, according to DIN 53294-1982, showed that the shear moduli of small specimens of PU foam were 21 kgf/m². However, the shear modulus of the entire sandwich panel determined using the four-point load method is more important.

For PU foam panels, the measured shear modulus GC is in the range of 40–45 kgf/m². In all our calculations we assume that the panels bend under uniformly distributed dead load, so there is only an external load that acts flatwise and downwards on a horizontal panel. The temperatures on the faces are considered to be equal for this purpose. The acceptable deflection of self-supporting ceiling and roof panels, on which a single person is allowed to walk during installation, is assumed to be L/200, where L is the length of span. For facade and wall panels, the allowable deflection is L/100.

Tables 20–23 show allowable loads for $x = L/200$.

Table 20.
Allowable uniformly distributed loads for PH Insulation construction panels with fixed edges

Panel thickness, mm	Allowable net load, kgf/m ²					Load distribution (allowable deflection = L/200)
	Length of panel, m					
	2	3	4	5	6	
40	141	82	52	33	21	
50	183	109	71	48	33	
60	224	136	91	63	44	
80	307	191	131	94	69	
100	390	246	171	125	94	
120	473	301	212	157	120	
150	598	383	273	206	160	
180	723	466	335	254	199	
200	806	521	376	287	226	

Table 21.
Allowable uniformly distributed loads for PH Insulation construction panels with free edges

Panel thickness, mm	Allowable net load, kgf/m ²					Load distribution (allowable deflection = L/200)
	Length of panel, m					
	2	3	4	5	6	
40	106	47	21	8	2	
50	144	68	34	16	7	
60	183	91	48	26	13	
80	263	139	79	46	27	
100	344	189	113	69	43	
120	426	241	148	94	61	
150	549	320	202	133	90	
180	673	399	259	175	121	
200	755	453	297	204	143	

Table 22.
Allowable central load for PH Insulation construction panels with fixed edges

Panel thickness, mm	Allowable net load, kgf/m ²					Load distribution (allowable deflection = L/200)
	Length of panel, m					
	2	3	4	5	6	
40	167	146	123	100	78	
50	216	194	170	145	119	
60	265	242	215	186	158	
80	363	339	309	278	245	
100	462	436	405	371	335	
120	560	534	502	466	427	
150	708	680	647	608	567	
180	856	827	792	752	708	
200	954	925	890	848	803	

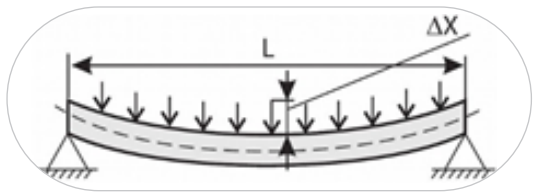
Table 23.
Allowable central load for PH Insulation construction panels with free edges

Panel thickness, mm	Allowable net load, kgf/m ²					Load distribution (allowable deflection = L/200)
	Length of panel, m					
	2	3	4	5	6	
40	133	91	56	29	7	
50	180	132	91	56	29	
60	227	175	127	86	53	
80	323	264	206	154	110	
100	420	356	289	228	174	
120	517	449	376	306	243	
150	663	591	511	430	355	
180	810	735	648	559	474	
200	908	831	741	647	555	

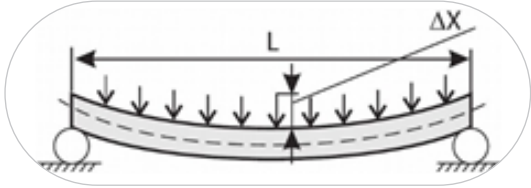
All the data above are of a theoretical nature and consider only uniformly distributed external load on the entire area of panel minus self-weight. Therefore, the calculated deflection includes both the applied loads and the dead load; this is especially important in the case of ceiling panels. We also assume that the adhesion bond between polyurethane foam and metal faces is absolute, and the bending deflection is L/200.

If during construction works someone is to walk on ceiling panels during their installation, it is strongly advised to choose the thickness using Table 24. This ensures that the panel withstands both the worker's weight and the panel's own uniformly distributed weight.

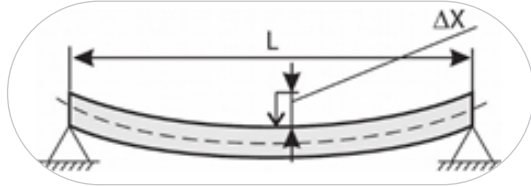
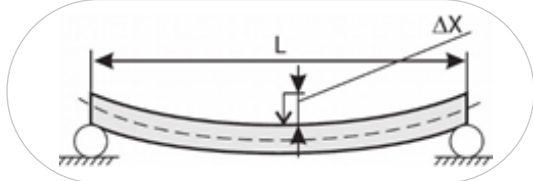
Table 24 shows the relationship between self-weight deflections of panels and the length of span. This information is useful when walking on ceiling panels is not required during installation or afterwards, and the panels therefore deflect only under their self-weight.

Table 24.
Self-weight deflections of ceiling panels (temperature of both faces is equal)

Thickness of panel, mm	Deflection at the center, mm		Mass of panel, kg
	Span length = 6 m		
	Fixed edges	Free edges	
60	5.8	13.6	75.7
80	4.3	8.9	81.3
100	3.4	6.6	87
120	2.9	5.3	92.7
140	2.6	4.4	98.4
150	2.4	4	101.3
160	2.3	3.8	104.1
180	2.1	3.4	109.8
200	2	3	115.5

* Please note that EN 14509 standard allows initial deflection of up to 1/500 of the length of panel in addition to the provided values.

3.3 MECHANICAL RESISTANCE OF ROOF PANELS

Roof panels significantly differ from wall panels, because one of the faces is deeply profiled (see Figures 27 and 28). This feature must be considered in design calculations.

Plenty of theoretical studies address the problem of bearing capacity of profiled panels. They involve some rather advanced mathematics, so we will use a simplified theory and assume that the load is distributed between flat and profiled parts of the panel and consider the two to be independent. Although both parts bend, only the deflection of metal faces is considered in the profiled part, whereas the deflection of the flat part is additionally affected by the shear of the core.

With this assumption, we obtain a simple formula for central deflection under a uniformly distributed load:

$$\Delta x = \frac{5E^3}{384B_s}(1-\beta)(1+k) \quad (23)$$

$$\beta = \frac{(1+k)B_D}{B_s + (1+k)B_D} \quad k = \frac{9,6B_s}{A_C G_{\phi\phi} L^2} \quad B_D = E_{F2} I_{F2} \quad (24)$$

$$B_s = \frac{E_{F1} A_{F1} E_{F2} A_{F2}}{E_{F1} A_{F1} + E_{F2} A_{F2}} e^2 \quad S = \frac{G_c e^2 b}{d_c} = A_C G_{\phi\phi} \quad (25)$$

where B_s = bending stiffness, S = shear stiffness of the flat part, $B_d = E_{F1} \cdot I_{F1} + E_{F2} \cdot I_{F2} \approx E_{F2} \cdot I_{F2}$ = bending stiffness of the profiled part (we assume that the lower layer is flat), $AC = b \cdot e$ = effective cross-sectional area of the core, e = effective thickness of the core, $E_{F1} = E_{F2}$ = elastic moduli of the upper and lower layers considered to be equal, and G_c is the shear modulus of the core.

Table 25 shows net loads at the center in kgf (after the deduction of self-weight) that cause a deflection of one-span roof panel to 1/200 of its length.

Table 25.

Allowable load on roof panels that lead to L/200 deflection (for uniformly distributed load)

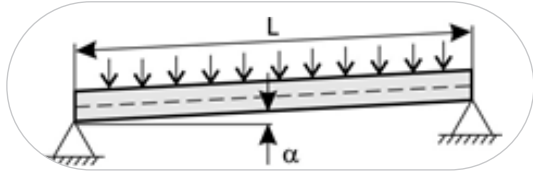
Panel thickness, mm	Length of span L, m						Load distribution (allowable deflection = L/200)
	Length of panel, m						
	1.5	2	3	4	5	6	
40	475	254	106	56	32	20	
60	583	333	154	86	53	34	
80	690	414	200	119	76	51	
100	800	490	250	150	97	69	
120	910	570	310	192	128	89	
150	1075	700	389	249	170	120	

Please note that the loads shown in Table 25 do not lead to the failure of roof panels, but rather to the deflection of 1/200 of their length. The calculations were performed for a horizontal flat roof; if the angle of the slope is α , multiply the values by $\cos \alpha$.

These data generally illustrate the allowable snow load on the roof made from sandwich panels. However, more exact calculations should also consider possible deflections due to the temperature differences on the faces. Please check the final design values of snow load on roof panels against local regulatory documents.

According to SP 20.13330.2016, Russia is divided into eight snow zones. The declared snow load in these areas is as follows:

Snow zones in Russia	Ia	II	III	IV	V	VI	VII	VIII
S_g , kgf/m ²	20	100	150	4 200	300	400	480	560

S_g values are shown for the weight of one square meter of snow cover. The design snow load for roof panels is:

$$S = S_g \cdot \mu \quad (26)$$

Coefficient μ depends on the slope of the roof. It is the cosine of the slope angle ($\cos \alpha$) mentioned above; however, SP 20.13330.2016 suggests a less strict approach:

- $\mu = 1$ for slope angles $< 25^\circ$
- $\mu = 0.7$ for slope angles $25\text{—}60^\circ$
- $\mu = 0$ for slope angles $> 60^\circ$

3.4 WRINKLING STRESS

As shown above, lateral load on the panel creates a moment of force that compresses its upper layer and extends its bottom layer. The compression stress on the upper face is defined by the formula (17).

$$\sigma_m^{\max} = \frac{Md}{2D} E_F = \frac{Md}{b\delta \cdot (d - \delta)^2} \quad (27)$$

We already provided theoretical values of the allowable loads that deflect panels to 1/200 of their length. In fact, however, the load is limited to a threshold value, after which the panel fails. This critical load is most often accompanied with wrinkling of the upper face of the panel (see Image 3). The failure stress σ_w is calculated from the following formula (2), (8), (10):

$$\sigma_{cki} = k \sqrt[3]{E_F E_C G_C} \quad (23)$$

As previously stated, E_F = elastic modulus of metal faces, E_C = elastic modulus of polyurethane core, and G_C = shear modulus of the core.

It is usually assumed that empirical coefficient k defines the quality of the panel and depends on the method of manufacturing:

- $k = 0.65$ for PU sandwich panels made on continuous production lines;
- k is $0.5\text{—}0.65$ for all other sandwich panels, including those with mineral wool core, or PU foam manufactured using a discontinuous lines.

In EN 14509 standard, $k = 0.5$ for all types of sandwich panels.

The moment of force, which arises when equally distributed force F acts across an unrestrained panel, is calculated as follows:

$$M = \frac{FLd}{8} \quad (28)$$

where F = total force that acts on the panel, including self-weight, and L = length of the panel. From formulas (26) and (28) for the stress, we obtain the following:

$$\sigma_m = \frac{FLd}{8\delta \cdot b(d - \delta)^2} \quad (29)$$

Then, the formula for the force that leads to wrinkling of the upper layer of sandwich panel is:

$$F = \frac{8b\delta \cdot (d - \delta)^2}{Ld} k \sqrt[3]{E_F E_C G_C} \quad (30)$$

Once again, the formula (30) describes full force F that acts on a unrestrained panel, including its self-weight.

Table 26.

Values of wrinkling stress (kgf) for 3 m and 6 m panels of various thicknesses without self-weight of panels. The values are shown for unrestrained supported panels.

Panel thickness, mm	L = 3 m	L = 6 m
40	390	143
50	499	194
60	607	247
80	822	350
100	1038	454
120	1250	557
140	1469	661
150	1577	712
180	1900	868
200	2115	971

3.5 UNIFORMLY DISTRIBUTED LATERAL LOAD ON VERTICAL FIXED PANELS / WIND LOAD ON STRUCTURES FROM SANDWICH PANELS

Although the calculations below are of a theoretical nature, they provide a realistic demonstration of the strength of sandwich panels with polyurethane cores.

In practice, external walls of structures mainly experience temperature and wind loads.

Let's consider the wind load on a fixed wall panel. The pressure on its surface is defined by Bernoulli's formula:

$$P = \frac{1}{2} \rho v^2 \quad (31)$$

where $\rho = 1,25 \text{ kg/m}^3$, and v = average wind speed at the site of construction.

Now, let's look at the allowable distributed load on a vertically fixed wall panel. The wind load can be considered as uniformly distributed with certain assumptions, so the resulting deflection of panel is described by the formula:

$$\Delta x = \frac{5E^3}{384E_F J_F} + \frac{E}{8E_C S_C} \quad (32)$$

The self-weight of panels should not be taken into account, because it acts across the wind load. According to European recommendations, allowable loads deflect the panel for up to $L/100$, where L = the length of the panel.

Table 27.
Allowable loads on a one-span wall panel

Panel thickness, mm	Allowable net load, kgf/m ²					Load distribution (allowable deflection = L/100)
	Length of panel, m					
	2	3	4	5	6	
40	264	126	67	39	25	
50	355	176	97	58	37	
60	448	230	131	80	51	
80	638	344	203	128	85	
100	831	463	282	182	123	
120	1026	585	365	240	165	
140	1220	710	452	302	210	
150	1320	773	496	334	234	
160	1418	837	540	367	258	
180	1615	964	630	433	308	
200	1813	1092	722	500	360	

Table 28.
Allowable loads on a two-span wall panel

Panel thickness, mm	Allowable net load, kgf/m ²					Load distribution (allowable deflection = L/100)
	Length of panel, m					
	2	3	4	5	6	
40	298	164	100	65	44	
50	389	219	137	91	63	
60	481	276	176	119	84	
80	670	393	258	179	129	
100	860	514	343	242	177	
120	1053	636	429	307	228	
140	1245	760	518	375	280	
150	1345	823	563	408	307	
160	1440	885	607	443	335	
180	1640	1010	698	512	390	
200	1834	1139	790	583	446	

If the wind speed is $v = 20$ m/s, the wind load is:

$$P_0 = \frac{1}{2} \cdot 1,25 \cdot 20^2 \text{ kg/m} \cdot \text{s}^{-2} = 250 \text{ N/m}^2 = 25 \text{ kgf/m}^2 \quad (33)$$

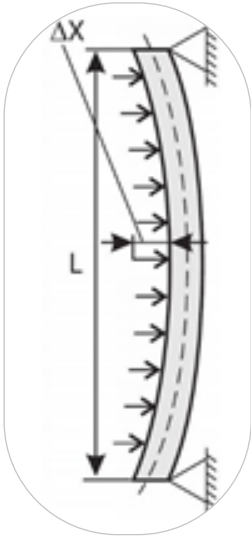
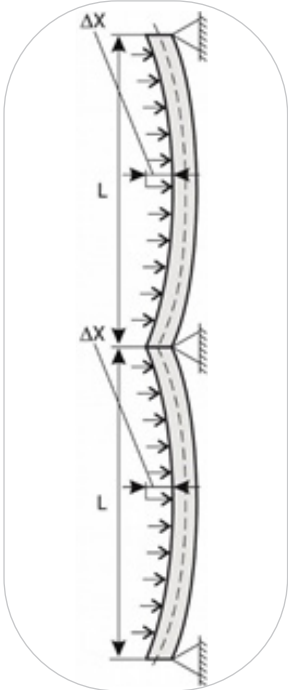
This load, for example, will deflect a 6 m long panel of 100 mm thickness to 6 mm from its normal position. According to SP 20.13330.2016 Loads and effects, some adjustment coefficients should be used when calculating the wind load:

$$P = P_0 \cdot C_e(z) \cdot C_p \quad (34)$$

where $C_e(z)$ depends on the category of place and on the height, and C_p is an aerodynamic coefficient that depends on the shape of the building and other factors.

Detailed guidelines for the calculation of these coefficients with respect to the latitude and the features of the place where the building is located – its proximity to the sea, mountains, other buildings etc. are provided in local regulations. After the wind load for the region and place is determined, the length of wall panels of certain thickness can be obtained from the table of allowable loads.

3.6 VERTICAL LOAD ON WALL PANELS

There are many theoretical and experimental studies on the resistance of sandwich panels to vertical (longitudinal) compression. Their conclusions confirm that relatively small panels are strong enough for the assembly of frameless structures.

According to these studies, vertical stress leads to at least four types of deformations in sandwich panels (see Figure 11).

Figure 11.

Possible deformations of sandwich panels due to axial (longitudinal) stress: A — general buckling, B — core shear failure, C — microstructural changes on faces, D — face wrinkling, E — face dimpling

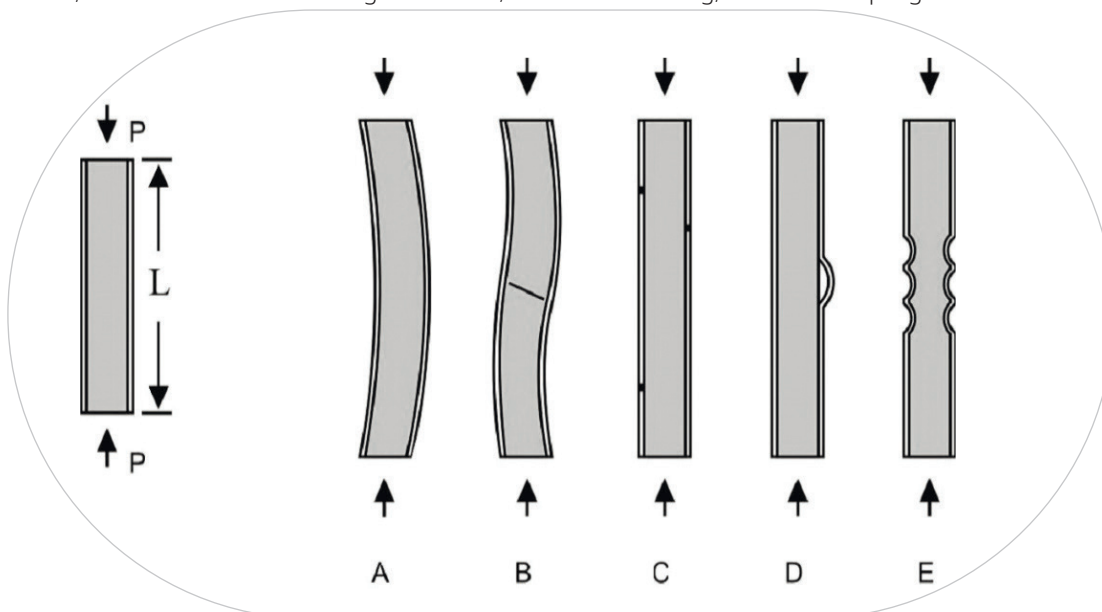

Let's assume that the panel is ideally flat. The stiffness of its metal faces is many times higher than the stiffness of the polyurethane core, so the faces resist all the longitudinal load. One possible type of panel deformation is general buckling (Figure 11A), which can increase up to the Euler load, or a critical point after which the deflected panel is unable to return to its initial position, and the deviation increases to infinity:

$$F_A = \frac{\pi^2 B_S}{\beta L^2} = \frac{\pi^2 b \delta \cdot (d - \delta)^2}{\beta L^2} E_F \quad (35)$$

Here, B_S is bending stiffness of the panel. Coefficient β depends on the method of fastening:

$\beta = 2$, if the panel is rigidly fastened at the bottom

$\beta = 1$, if the panel is hinged at the top and at the bottom

$\beta = 0,699$, if the panel is rigidly fastened at the bottom and hinged at the top

$\beta = 1/2$, if the panel is rigidly fastened at the top and at the bottom

Core failure is defined by its shear modulus:

$$FB = b^*(d - \delta)G_c \quad (36)$$

where b is the width of the panel (1,190 mm in this case), δ is the thickness of the metal face (0.5 mm), and G_c is the shear modulus of the polyurethane core.

It should be noted that the Euler load, which leads to panel buckling, may be lower than the load that leads to core failure. Although it is simpler to describe the types of deformation separately, in practice they more often occur together and after some critical point lead to the global failure of the panel. The amount of this load is defined by the formula:

$$\frac{1}{F_c} = \frac{1}{F_A} + \frac{1}{F_B} \quad (37)$$

Table 29.

Critical stress that leads to irreversible failure of vertically loaded panels

Panel thickness, mm	F_{cr} (for $\beta = 2$)		
	L = 2.5 m	L = 3 m	L = 6 m
40	4065	3230	1070
50	5700	4680	1630
60	7620	6270	2300
80	11600	9800	3900
100	15800	13600	5820
120	20200	17700	8400
140	24700	21600	10400
150	27000	24100	11700
180	34000	30700	15900
200	38700	35300	18900

Wrinkling and buckling of panels occur at a critical stress defined by formula (23). The load (except for rotation and twisting) that leads to these types of failure in perfectly flat vertically installed panels, fastened at the bottom, is as follows:

$$F_c = 2\delta \cdot bk\sqrt[3]{E_c E_f G_c} \approx \delta \cdot b\sqrt[3]{E_c E_m G_c} \approx 6620 \text{ kgf} \quad (38)$$

if this load does not lead to the global failure.

For the purposes of (38), the faces are equal, as previously, and $k = 0.5$.

CHAPTER 4: WALL AND ROOF SANDWICH PANELS BY PH INSULATION

4.1 LABELING

PH Insulation panels are labeled according to the pattern below.

Labeling scheme:

X	X	X	X.X.X	—	X	/	X	—	X
1	2	3	4		5		6		7

1. Type of insulation (PIR Premier or PUR Classic)
2. Panel structure (PWT for three-layer wall panels, PRT for three-layer roof panels)
3. Locking system:
 - Standard for wall panels
 - Z-lock for wall panels (Z)
 - Standard lock for roof panels
 - Z-Lock for roof panels (Z)
4. Dimensions (length in cm, width and thickness in mm)
5. Type of external face
6. Type of internal surface
7. Designation on packing lists or in accompanying documents

For example, a three-layer wall panel with PIR Premier insulation, standard locking system, length = 600 cm, width = 1,190 mm, thickness = 100 mm, zinc-coated steel external face, and inner face covered with 25–30 µm layer of RAL 9003 polyester is labeled:

PIR PWT 600.1190.100 — Zn/Ral9003

4.2 GEOMETRY

1. Type of panel:
 - PUR PWT: wall panels with PUR Classic core
 - PIR PWT, PIR PWT Z, PIR PWT SF: wall panels with PIR Premier core
 - PIR PRT, PIR PRT Z: roof panels with PIR Premier core
2. Type of locking system:
 - Standard for PWT and PRT
 - Z-Lock (Z) for PIR PWT and PRT
3. Cover width:
 - PUR PWT and PIR PWT: 1,190 mm
 - PIR PWT Z: 1,190 mm
 - All types of panels: 1,000 mm
4. Minimum length: 2,000 mm for all types of panels
5. Maximum length:
 - PUR PWT: 9,300 mm
 - PIR PWT; PIR PWT Z, PIR PWT SF: 16,000 mm
 - PIR PRT; PIR PRT Z: 13,600 mm
6. Thickness of sandwich panels:
 - 40, 50, 60, 80, 100, 120, 140, 150, 160, 180, 200 mm
 - 40, 50, 60, 80, 100, 120, 150, 200 mm

- 50, 60, 80, 100, 120, 150, 200 mm
- 30, 40, 60, 80, 100, 120, 150 mm
- 50, 60, 80, 100, 120, 150, 200 mm

Profiles on metal faces provide panels with additional rigidity. Dimensions, types of locking systems, and types of profiles are shown in the figures below:

Figure 12.
Geometry of wall panels with standard locking system (PWT)

Panel Width 50 mm

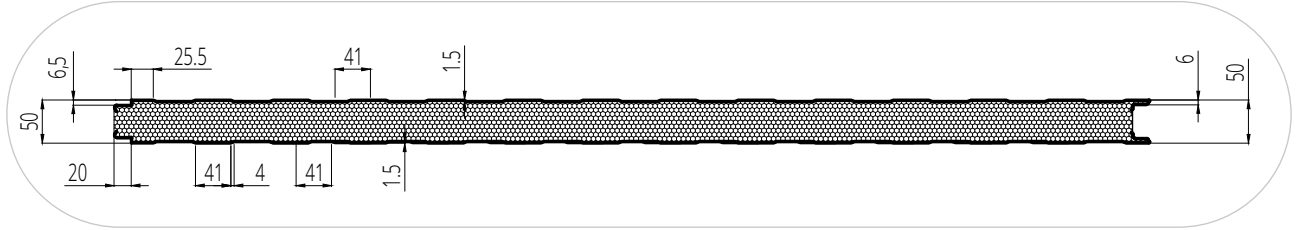

Panel Width 80 mm

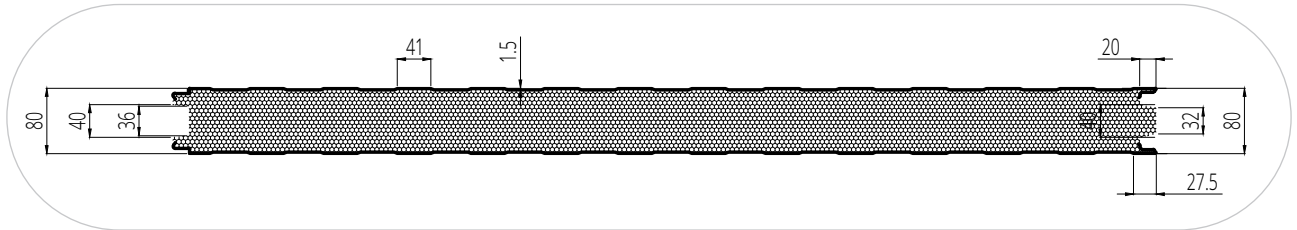

Panel Width 100 mm

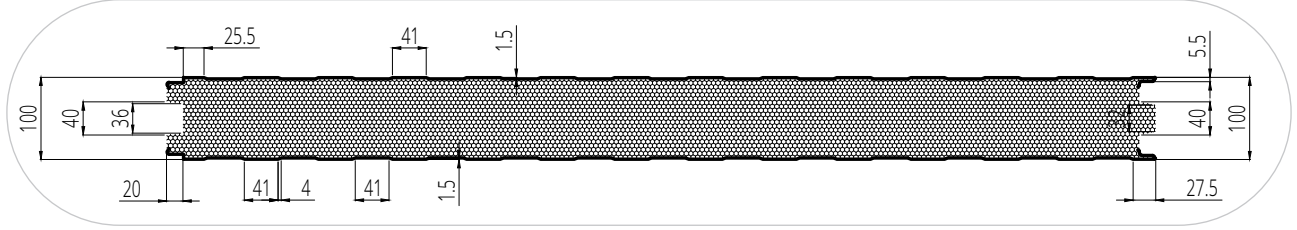

Panel Width 120 mm

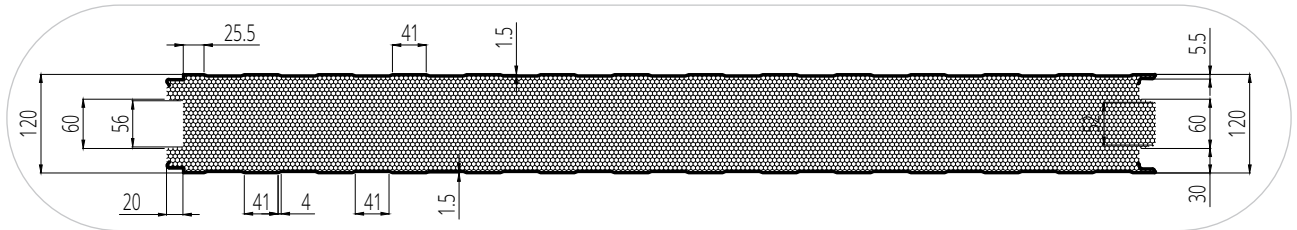

Panel Width 150 mm

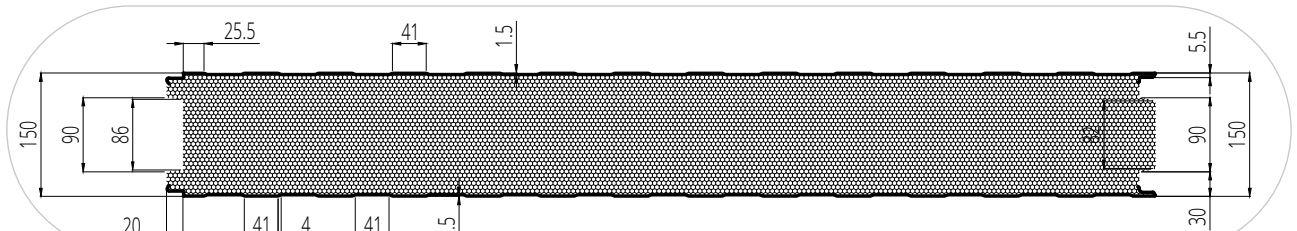

Panel Width 200 mm

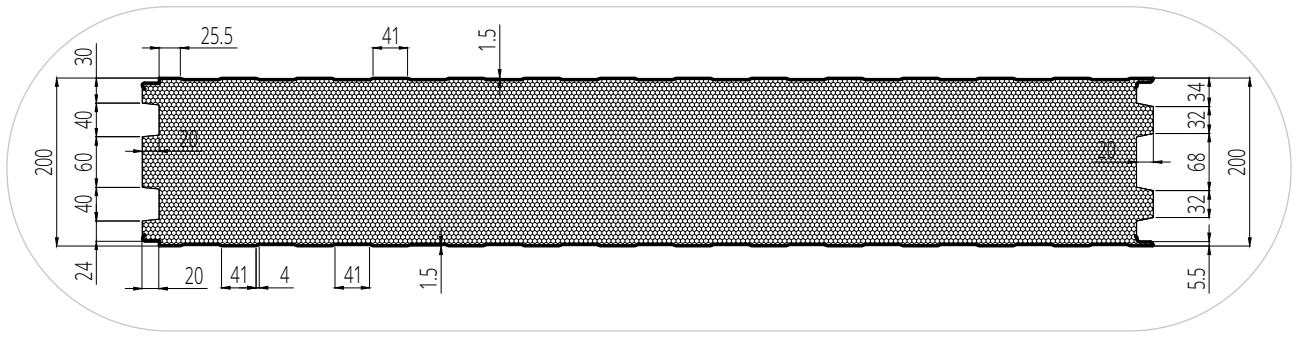

Figure 13.
Joint of wall panels with standard locking system

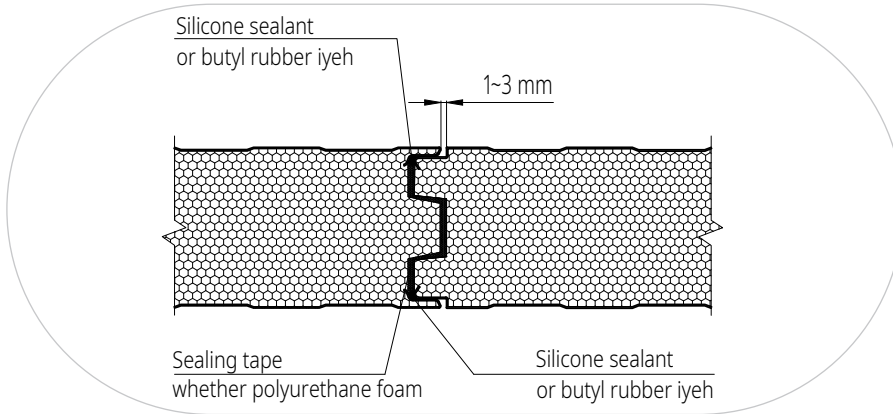
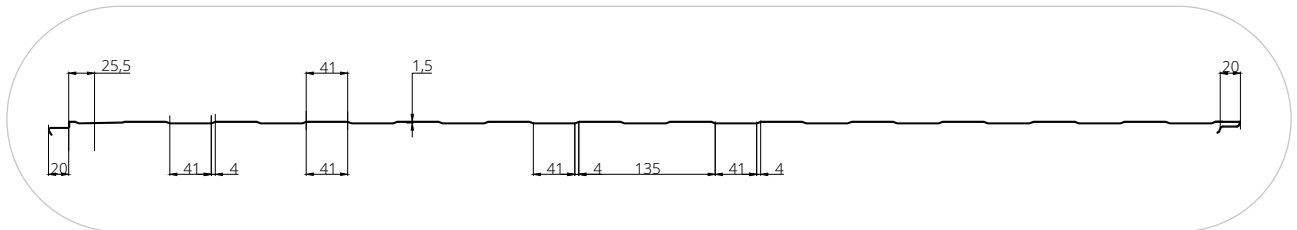

Figure 14.
Types of profiles on the internal face of PWT panels

Standard ProfHolod Profile



No Profile



Figure 15.
Types of profiles on the external face of PWT panels

Standard ProfHolod Profile

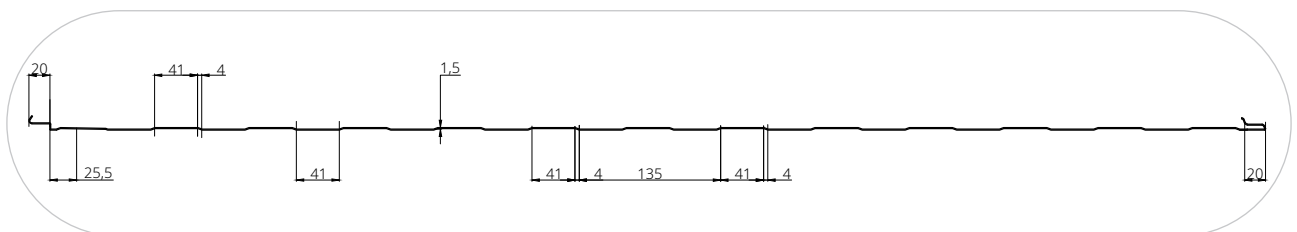

No Profile



Figure 16.
Geometry of panels with Z-Lock system (PWT Z)

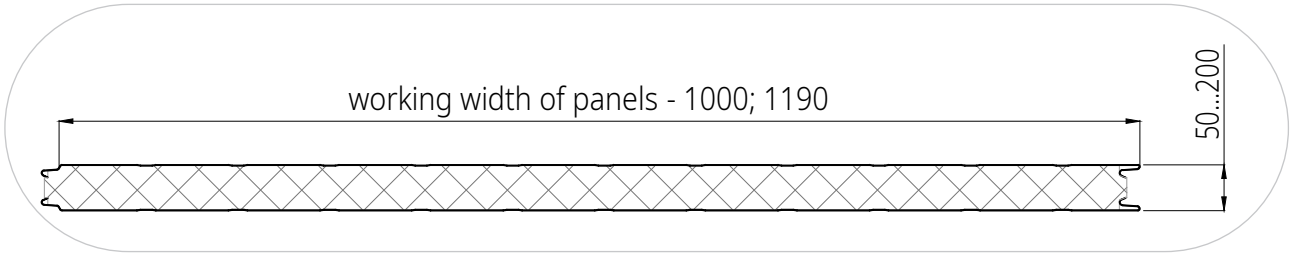

Figure 17.
Joint of wall panels with Z-Lock system

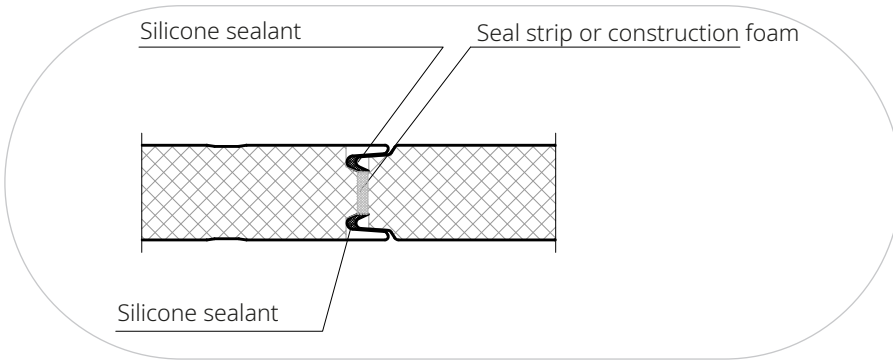
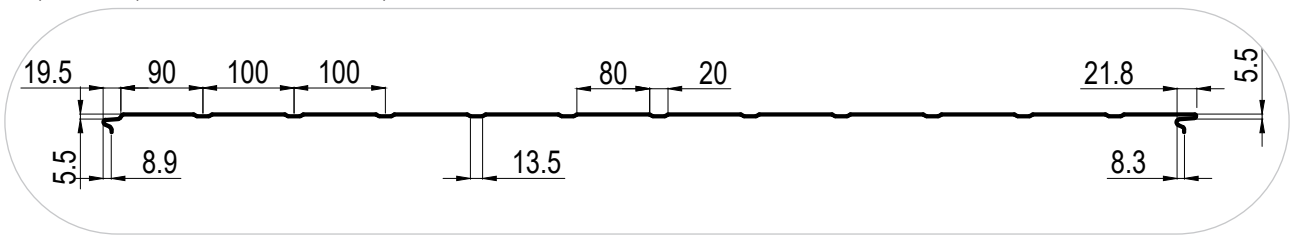
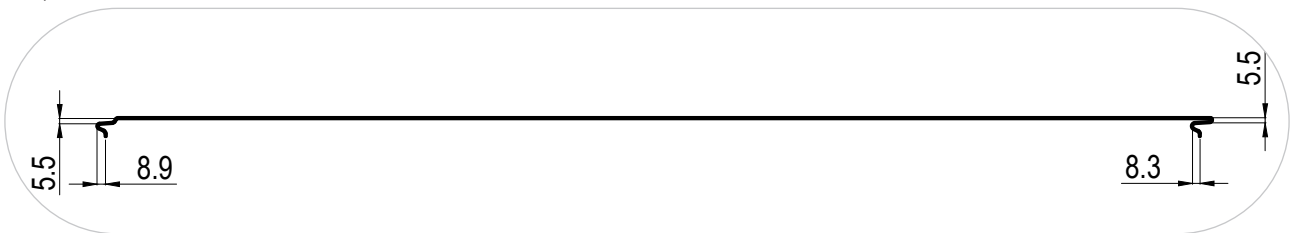

Figure 18.
Types of profiles on the internal face of PWT Z panels

Trapezoidal profiles with 100 mm span (T1)



No profiles



Standard ProfHolod Profile

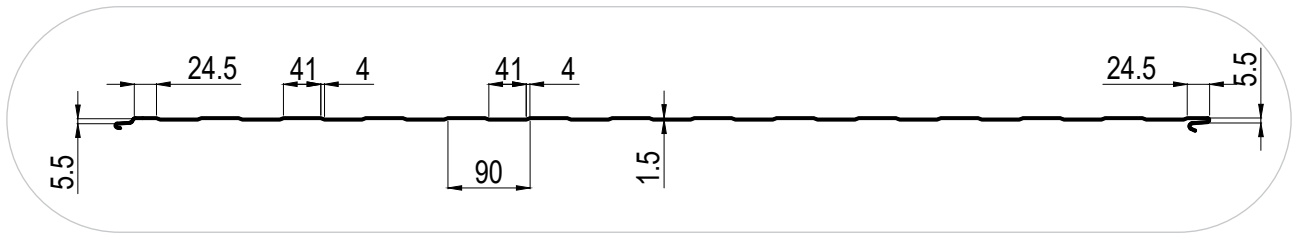
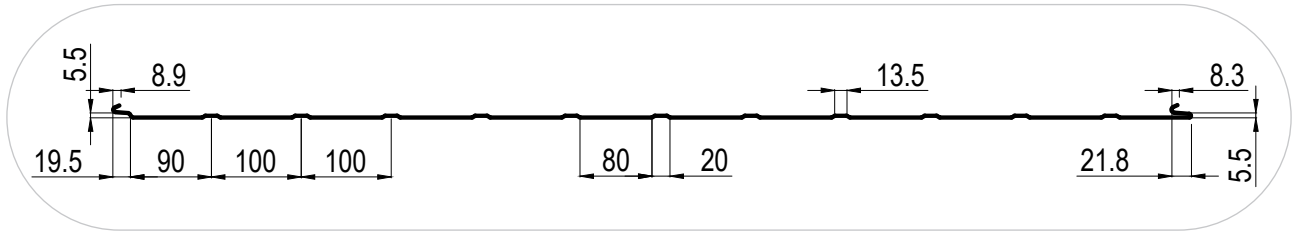
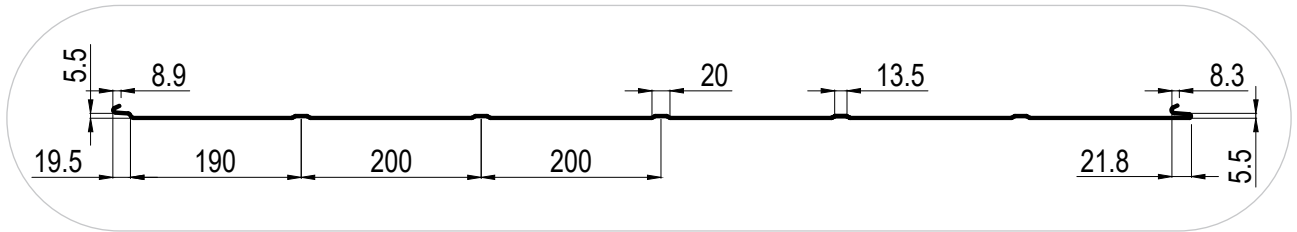

Figure 18.
Types of profiles on the external face of PWT Z panels

Trapezoidal profiles with 100 mm span (T1)



Trapezoidal profiles with 200 mm span (T2)



Standard ProfHodol Profile

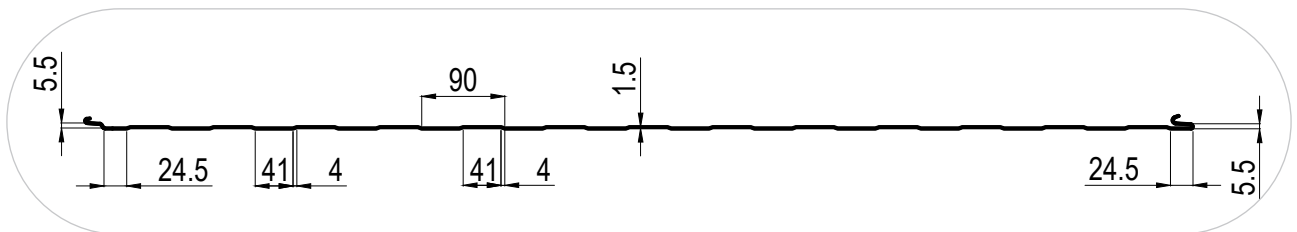

No profiling

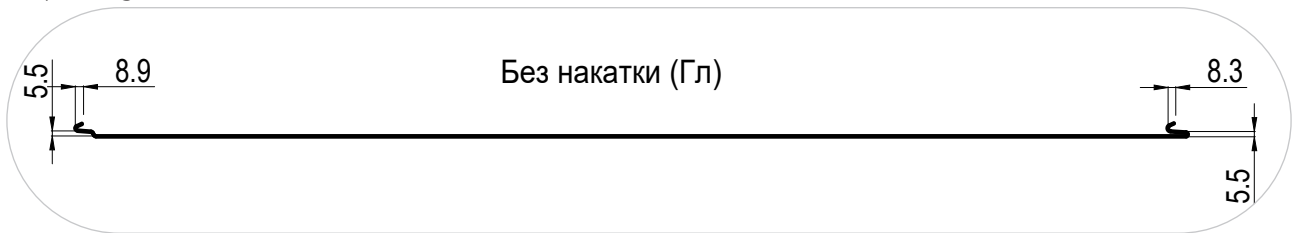
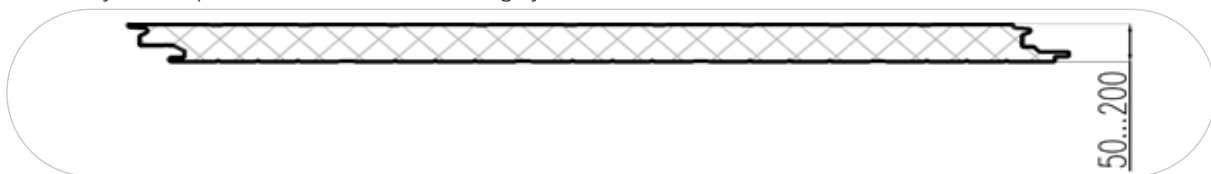

Figure 20.
Geometry of wall panels with Secret Fix locking system (PWT SF)



In a locking system, the edge of the face enters a slot in the core and reliably connects two panels.

This principle significantly reduces the risk of damage during transportation and installation. On request, wall panels manufactured using a molding technique may be equipped with tightening cam locks along the edge for the better

adjustment of panels during installation.

Figure 23.
PUR PWT panels with a cam lock system

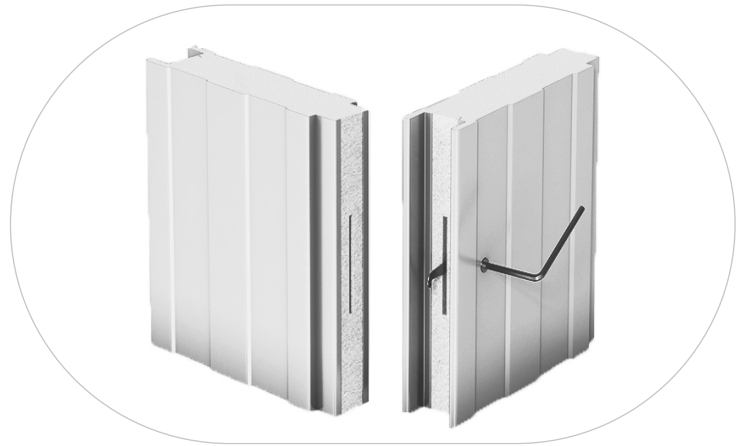

Figure 24.
Geometry of roof panel with a standard locking system

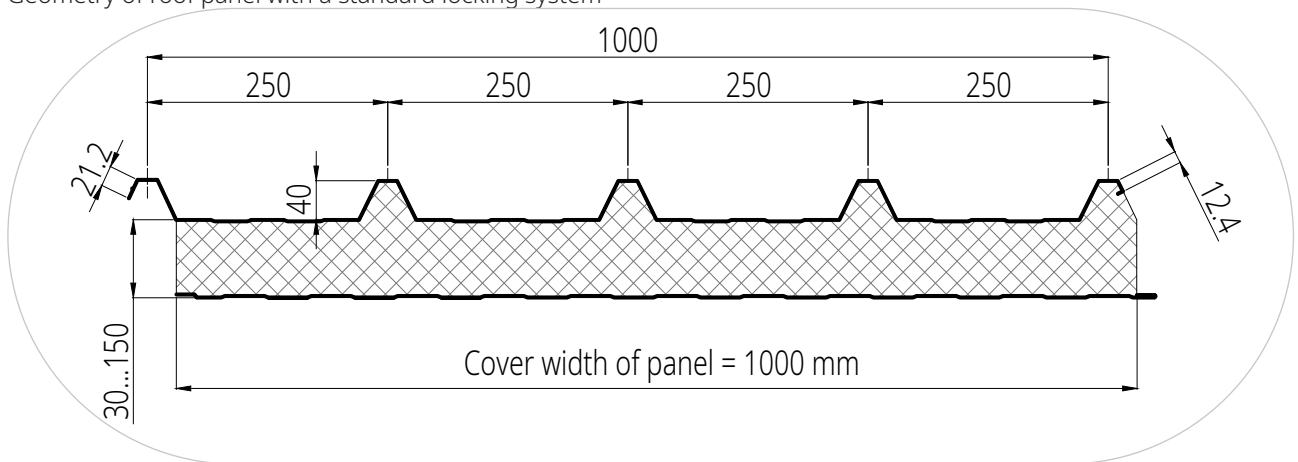

Figure 25.
Joint of roof panels with a standard locking system

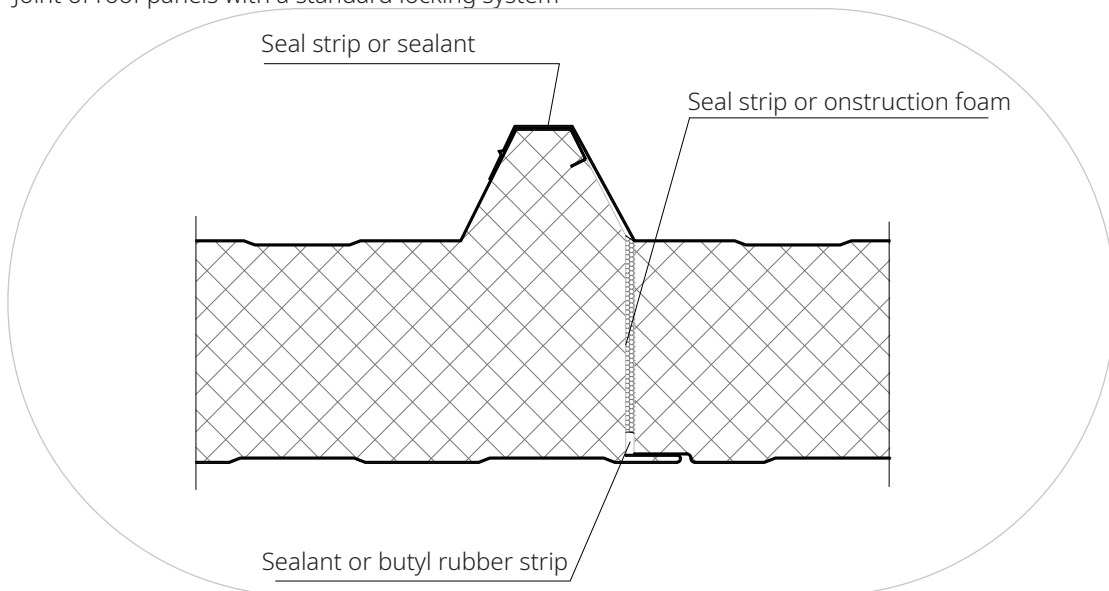
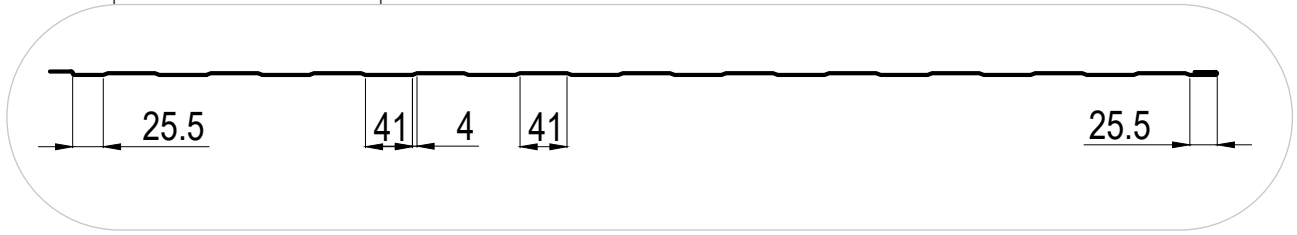

Figure 26.
Types of profiles on the internal face of PRT panels

Standard profiles of PH Insulation panels



No profiles



Figure 27.
Types of profiles on the external face of PRT panels

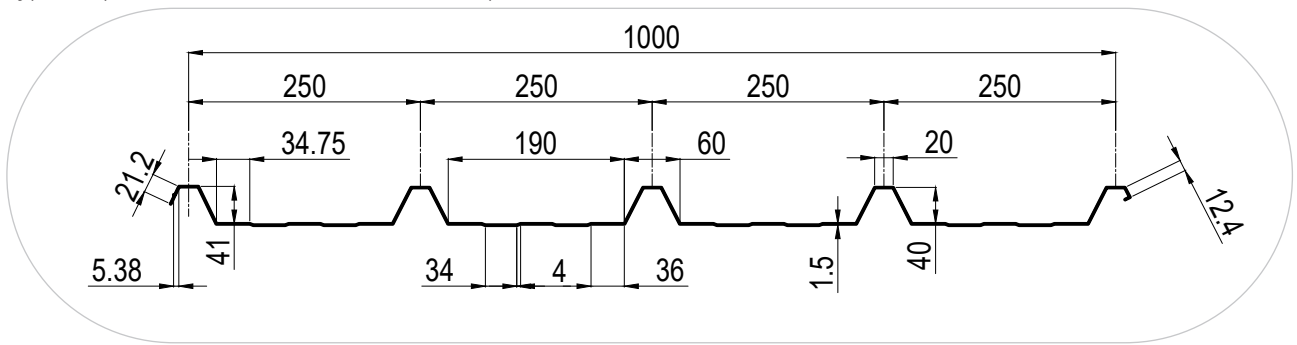

Figure 28.
Geometry of roof panel with Z-Lock system (PRT Z)

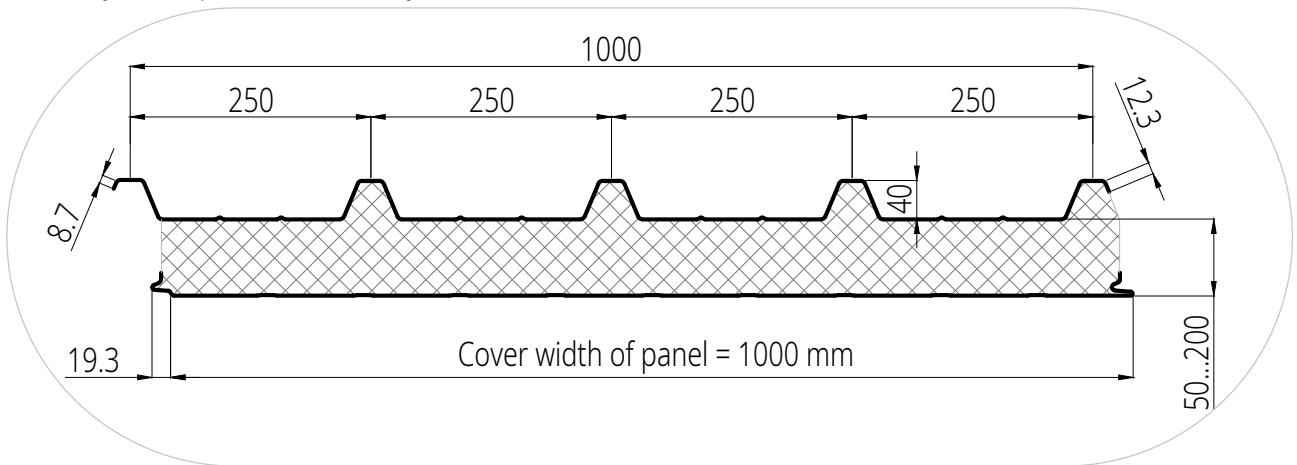

Figure 29.
Joint of roof panels with Z-Lock system

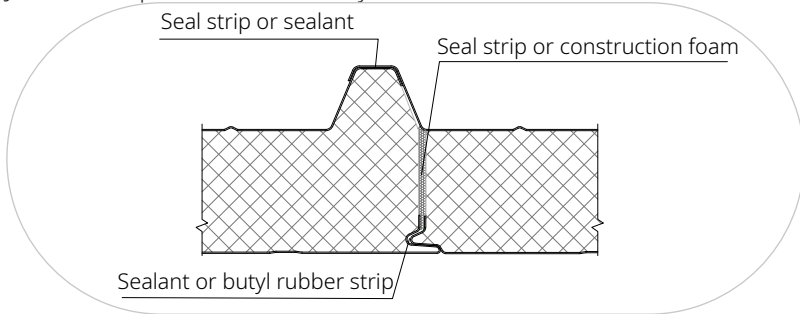
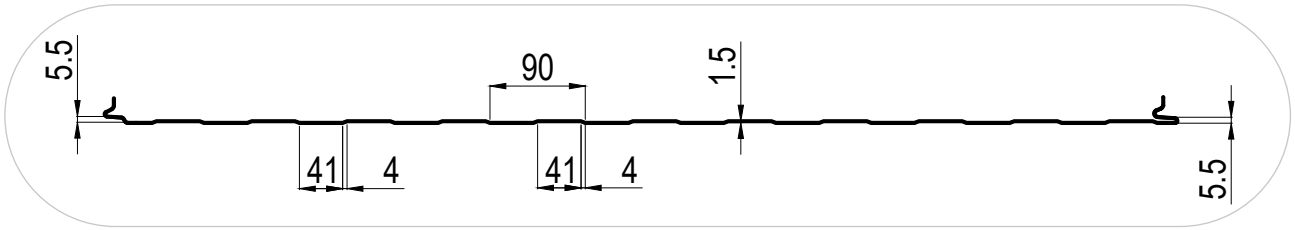
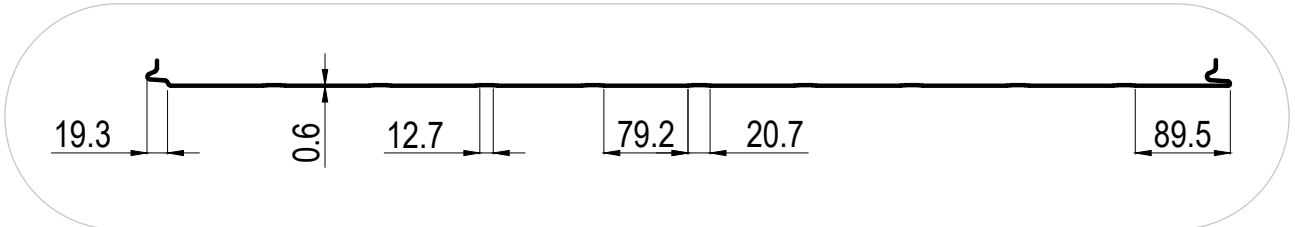

Figure 30.
Types of profiles on the internal face of PRT Z panels

Standard ProfHolod Profile



Trapezoidal profiles with 100 mm span (T1)



No profiles



Figure 31.
Types of profiles on the external face side of PRT Z panels

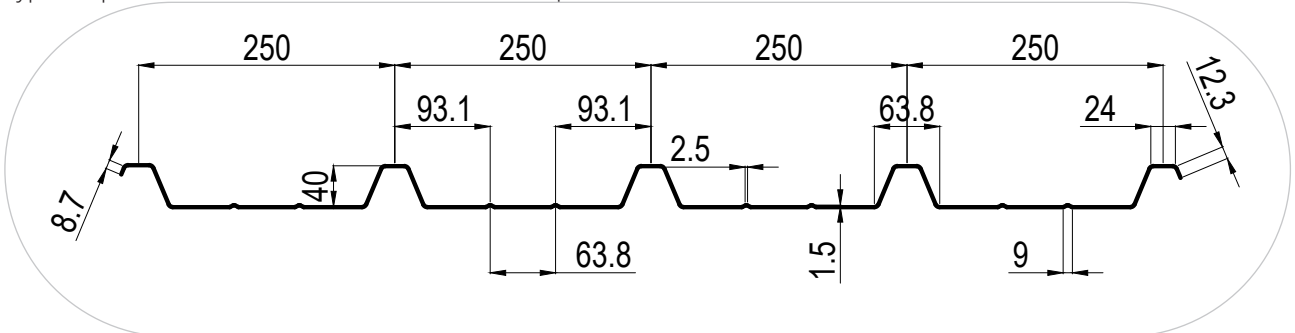

Table 30.
Colors of sandwich panels according to RAL Classic standard

Name	Number
Ivory	RAL 1014
Light ivory	RAL 1015
Signal blue	RAL 5005
Leaf green	RAL 6002
Moss green	RAL 6005
Signal grey	RAL 7004
Light gray	RAL 7035
Chocolate brown	RAL 8017
Grey white	RAL 9002
Signal white	RAL 9003
White aluminum	RAL 9006

Other RAL colors available upon request.

CHAPTER 5: GENERAL RULES FOR HANDLING, CUTTING, TRANSPORTATION, AND STORAGE OF SANDWICH PANELS

5.1 CUTTING

PIR and PUR sandwich panels should be cut with a jigsaw or circular saw, and a special blade for sandwich panels should be used. This makes the line of cut smooth and prevents jagging (see Images 4 and 5). Do not remove protective foil before cutting.

Do not cut sandwich panels with an angle grinder!

5.2 PACKING, TRANSPORTATION, AND STORAGE

PACKING OF SANDWICH PANELS

Metal faces of PH Insulation sandwich panels are protected with 35—50 µm polyethylene wrap, which should be removed after installation.

Please note that the removal of the wrap before the installation may lead to damaging of the panels. We also advise removing the wrap immediately after installation and no later than three months after the panel is manufactured. After this time, it may be difficult to remove the wrap, and panel coating may deteriorate.

Panels are stacked in packs up to 1,200 mm high. The number of panels in each pack depends on their type and thickness.

To prevent friction during transportation, cardboard sheets are used.

All packs contain a note with a packing list, where the order number, amount, size, type, and total weight of the panels is indicated.

PACKING OF PIR PREMIER PANELS

Corners of packs are protected with vertical metal angles.

For roof panels, additional cardboard angles are added on the corners to protect them from friction during transportation.

The pack is wrapped with stretch wrap, and the upper layer of the coil is fastened. The overlap of the wrap in the layer is 35—40%.

The packs are placed on strong Styrofoam supports, 8 cm thick and 35 kg/m³ dense. The number of supports depends on the length of the panels.

PACKING OF PUR CLASSIC PANELS

In places of contact of packing wrap with the edges of locking system, additional plastic or cardboard angles are placed under the wrap to protect the panels from friction during transportation.

Corners of package are protected with vertical metal angles.

The pack is wrapped with stretch wrap and placed on strong Styrofoam supports 8 cm thick and 35 kg/m³ dense. The number of bars depends on the length of panels.

Photo 6-1.
Wall Sandwich Panels Packs

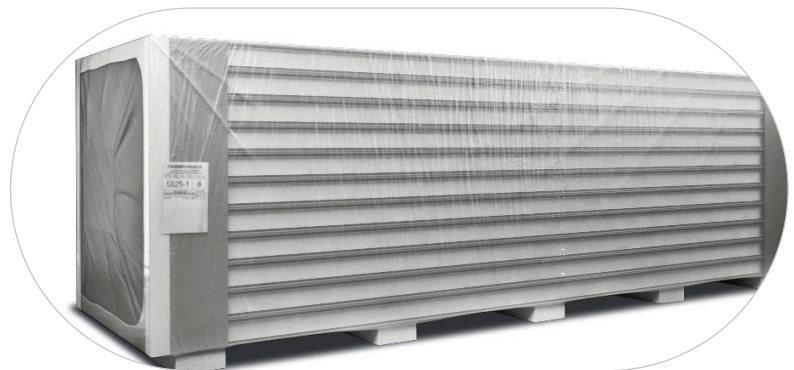

Photo 6-2.
Roof Sandwich Panels Packs



TRANSPORTATION

General considerations

PH Insulation will deliver the products to any destination in Russia and abroad by road, rail, and sea. This is the best option, because each load needs a carefully selected mode of transportation and responsible delivery service. PH Insulation uses online auctions to hire professionals for a reasonable price and safely deliver your order as soon as possible.

If you would prefer to arrange delivery of your sandwich panels independently, please make sure that the trucks of the company you choose are not equipped with self-engineered equipment (hacks, angles etc.); this may reduce the area of the body and damage the panels during transportation.

Loading of sandwich panels is performed from the sides, so sliding stakes should be placed on both sides of the truck.

The internal dimensions of the semi-trailer should be 13,600 × 2,450 × 2,600 mm (LWH). If they are even 2–3 cm smaller, the panels may not fit, and another truck may be required. Therefore, please make sure that the deliverer understands the importance of precise dimensions.

The body should be clean, flat, and free of foreign objects.

Ask the deliverer if the truck is equipped with any stakes for large-size and long loads, for example tubes or timber. These reduce the actual loading space, so the panels may not fit even if the dimensions of the truck meet the formal requirements.

The driver should bring 6–10 cargo straps. PH Insulation does not sell or rent such equipment.

During transportation, stability and fastening of the panels should be controlled, and loose straps should be tightened. Molded elements should not touch the surface of panels during transportation.

Do not put other loads on packs.

MODE OF TRANSPORTATION

Most often, the panels are transported by road, for example in a flatbed truck, side truck, or covered truck. Please note that some vehicles are not suitable for the transportation of sandwich panels and doors for cold rooms.

Suitable options:

1. Flatbed trucks are suitable for short distances. If the distance is over 700 km, we strongly advise against this option because headwind and precipitation may damage the cargo.
2. Side trucks
3. Curtain or covered semi-trailers

CONTAINERS

20' standard, 40' standard, and 40' high-cube cargo containers are available. If you want to transport PH Insulation products in a container, please notify your project manager in advance and pay attention to the internal dimensions.

Please note that some semi-trailers are NOT suitable for transportation of panels and doors for cold chambers due to construction features; it is physically impossible to load our products to such trucks. Therefore, we recommend arranging the type of truck with the manager of your project in advance.

If a truck is equipped with a tail lift, the forklift will not be able drive close and properly load or unload packs of sandwich panels.

Side stakes will also be an obstacle, because the panels are loaded from the side.

If the truck is equipped with permanent or non-sliding stakes, it will be impossible to safely load the packs of sandwich panels or doors for cold storages.

CONTRACTORS

Some transportation companies on the delivery market are unreliable. Please make sure that your partner is trustworthy.

Check their constitutional documents and tax reports and look for references.

We advise against companies with a period of registration of less than a year or with a legal address in a place of mass registration.

STORAGE

Store sandwich panels on a flat surface (maximum 5% slope), up to two packs in a stack. The total height of the stack should not exceed 2.4 m. The upper pack should not extend beyond the bottom one. Place wooden supports (at least 10 cm thick) under the bottom pack with a maximum 1 m span between the supports.

Store sandwich panels in their waterproof factory package in an open or semi-closed warehouse and follow the fire safety procedures. Keep the panels away from moisture.

During short-term outdoor storage, protect the panels from direct sunlight, dust, and precipitation. Gently tilt the packs to prevent the accumulation of rainwater.

PLEASE DO NOT:

- put any loads on packs;
- put the second row of packs with a shift in respect to the bottom row;
- walk on panels;
- lift packs by the edge.

Table 31 shows the number of wall panels in a standard factory pack, and the number of packs in a standard truck.

Table 31.

The number of full packs of wall panels (width = 1,190 mm) in a standard truck with internal dimensions 13.4 × 2.45 × 2.6 m

Thickness of panels, mm	Panels per pack	Height of pack, m	Area of 16 packs, (L=3 m), m ²	Area of 12 packs, (L=4 m), m ²	Area of 8 packs, (L=5 m), m ²	Area of 16 packs, (L=6 m), m ²	Area of 4 packs, (L=3 m), m ²
40	18	0.8	1024	1024	853	1024	683
50	18	0.98	1024	1024	853	1024	683
60	18	1.16	1024	1024	853	1024	683
80	14	1.2	796	796	664	796	531
100	11	1.18	626	626	521	626	417
120	9	1.16	512	512	427	512	341
140	8	1.2	455	455	379	455	303
150	7	1.13	398	398	332	398	265

Table 32. The number of full packs of roof panels (width = 1,000 mm) in a standard truck with internal dimensions 13.4 × 2.45 × 2.6 m

Thickness of panels, mm	3 m panels			4 m panels		
	Panels per pack	Height of pack, mm	Packs per truck	Panels per pack	Height of pack, mm	Packs per truck
30	22	1180	16	22	1180	12
40	18	1160		18	1160	
60	14	1200		14	1200	
80	10	1080		10	1080	
100	8	1040		8	1040	
120	8	1200		8	1200	
150	6	1100		6	1100	
200	4	960		4	960	

Table 33. The number of full packs of roof panels (width = 1,000 mm) in a standard truck with internal dimensions 13.4 × 2.45 × 2.6 m

Thickness of panels, mm	3 m panels			4 m panels		
	Panels per pack	Height of pack, mm	Packs per truck	Panels per pack	Height of pack, mm	Packs per truck
30	22	1180	8	14	780	6
40	18	1160		12	800	
60	14	1200		14	1200	
80	10	1080		10	1080	
100	8	1040		8	1040	4
120	8	1200		8	1200	
150	6	1100		6	1100	
200	4	960		4	960	

Image 7. Factory-packed sandwich panels

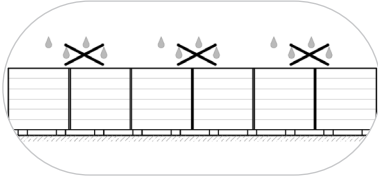

Table 34 shows the number of wall and roof panels in a pack depending on their thickness, and tentative weight of one running meter of panels in a pack.

Table 34.
Standard factory packs of PH Insulation sandwich panels

Type	Panel thickness, mm	Panels per pack	Height of pack, mm	Weight of pack per 1 running meter, kg
Wall panels (width = 1,190 mm)	40	28	1210	328
	50	22	1190	268
	60	18	1170	228
	80	14	1210	191
	100	11	1190	161
	120	9	1170	140
	140	8	1210	132
	150	7	1140	119
	160	7	1210	122
	180	6	1170	111
Roof panels (width = 1,000 mm)	200	5	1090	97
	30	22	1190	191
	40	18	1170	198
	60	14	1210	165
	80	10	1090	126
		12	1290	151
	100	8	1050	107
		10	1290	134
	120	8	1210	114
	150	6	1110	93
	4	960	70	

Table 35.
 General recommendations for storage of sandwich panels



Keep away from moisture.
 Control package integrity.

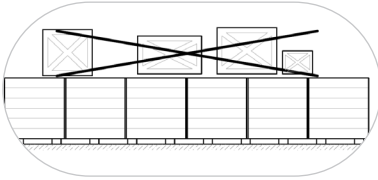

Do not put other objects on the surface of panels.

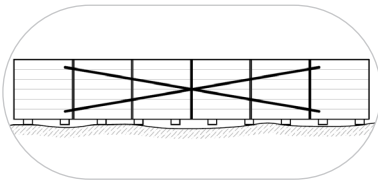

Store panels on a flat surface.

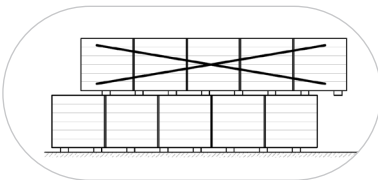

Avoid overhanging of the second row.

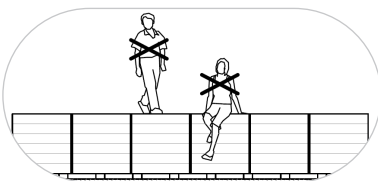

Do not walk on panels.

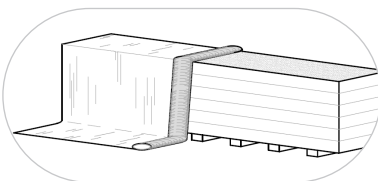

Protect panels from direct sunlight.

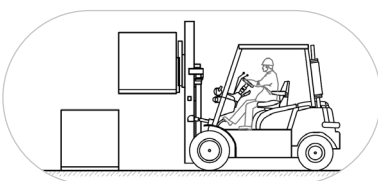

Lift packs one by one.

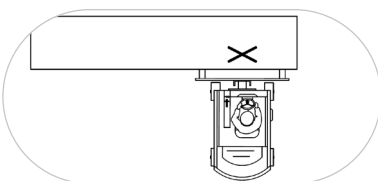

Do not lift by the edge.

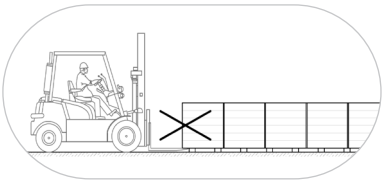

Do not jolt.

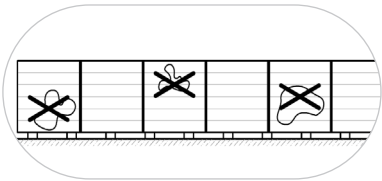

Avoid contamination.

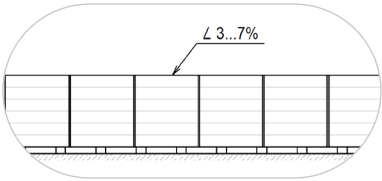

Place the panels with a gentle lengthwise slope.

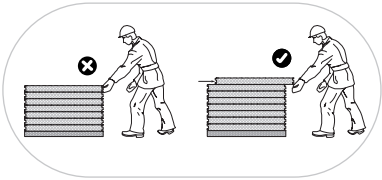

Do not lift panels by the lock

CHAPTER 6: FRAMELESS STRUCTURES FROM SANDWICH PANELS

6.1 GENERAL INFORMATION

Self-supporting sandwich panels and metal elements are used to assemble frameless cold rooms and freezers. These structures can be both modular and conventional and maintain a required temperature in a closed space.

Prefabricated cold rooms that are intended to move after some period of usage are made from sandwich panels equipped with tightening cam lock systems. They can be easily assembled almost everywhere and quickly dismantled and moved if necessary.

Figure 32.
A conventional cold room from sandwich panels



The cold room is assembled from wall, floor and ceiling panels, and metal elements of the same type and color as panel faces. The floor panels should be enhanced with plywood sheets or aluminum checker plates, because sandwich panels are not strong enough for constant walking and movement of forklifts and carts.

On request, prefabricated cold rooms are supplied with expendable materials, such as screws for metal elements, anchor bolts, silicone sealants, and construction foams.

6.2 STRUCTURE AND ASSEMBLY OF COLD ROOMS

Cold rooms are assembled from sandwich panels with 0.5 mm zinc-covered faces and metal elements. These self-supporting structures, if installed properly, provide thermal insulation and significantly reduce refrigeration costs. These types of cold and deep-freeze chambers meet sanitary requirements for food storage.

Figure 34 shows the three main parts of the structure.

A set of panels and metal elements to assemble a cold room is supplied with a detailed assembly diagram and a packing list.

First, check if all panels and other elements are present and prepare the construction site.

Figure 33.
A diagram of a cold chamber

- I. Joint of floor and wall sandwich panels
- II. Joint of wall panels
- III. Joint of ceiling and wall panels

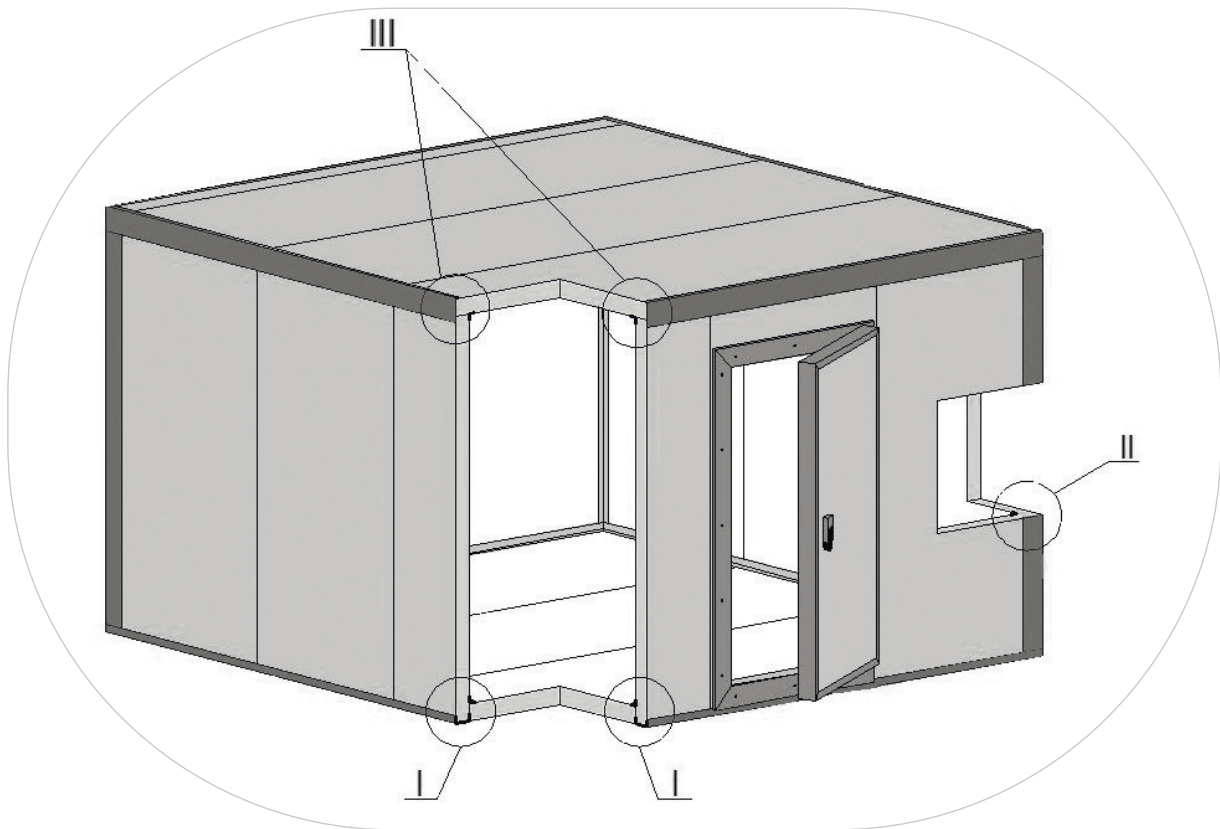
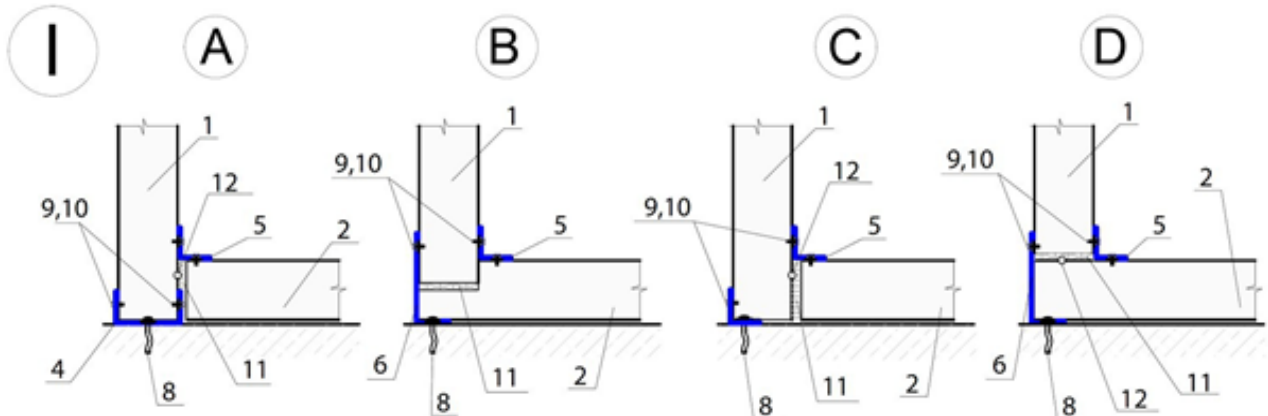

Figure 34.
Main joints of sandwich panels in a cold room

- 1. Wall panel
- 2. Floor panel
- 3. Ceiling panel
- 4. Channel for wall panels
- 5. Inner angle, 40–40 mm
- 6. Unequal external angle
- 7. Equal external angle
- 8. Wedge bolt (450 mm span)
- 9. Screws for metal elements (200–300 mm span)
- 10. All-purpose sealant
- 11. Construction foam
- 12. Cut in metal face to prevent thermal bridges

Types of fastening of wall and floor panels



Types of fastening of wall panels in the corners of a cold room

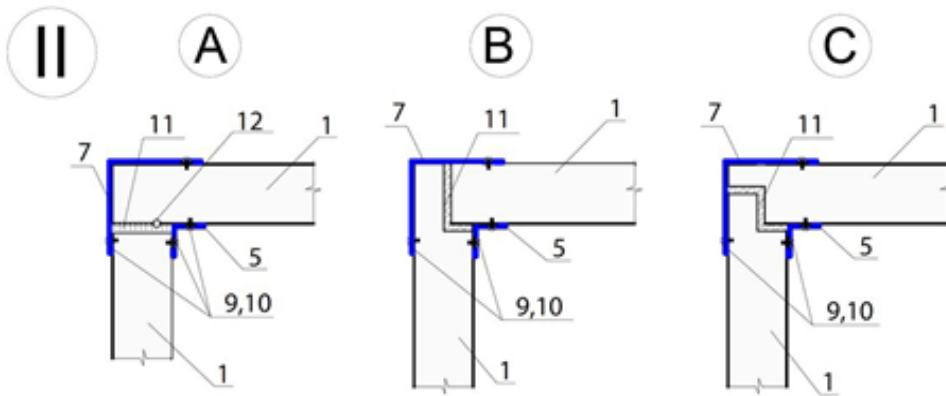

Types of fastening of wall and ceiling panels

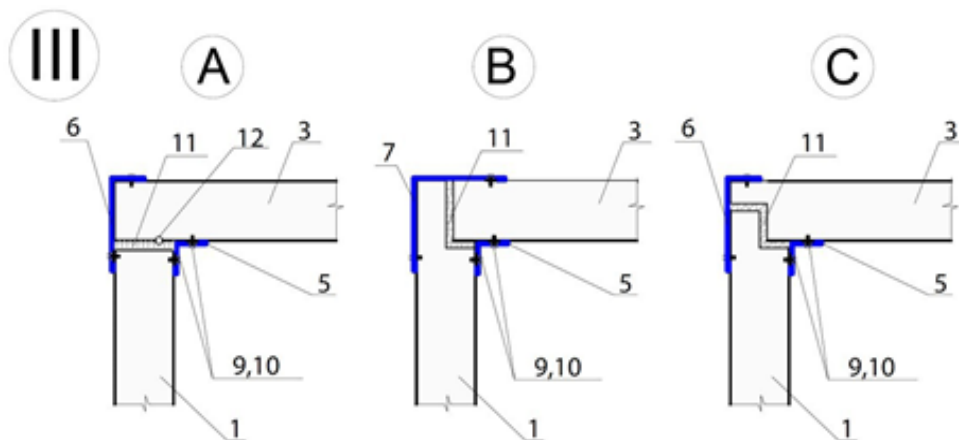
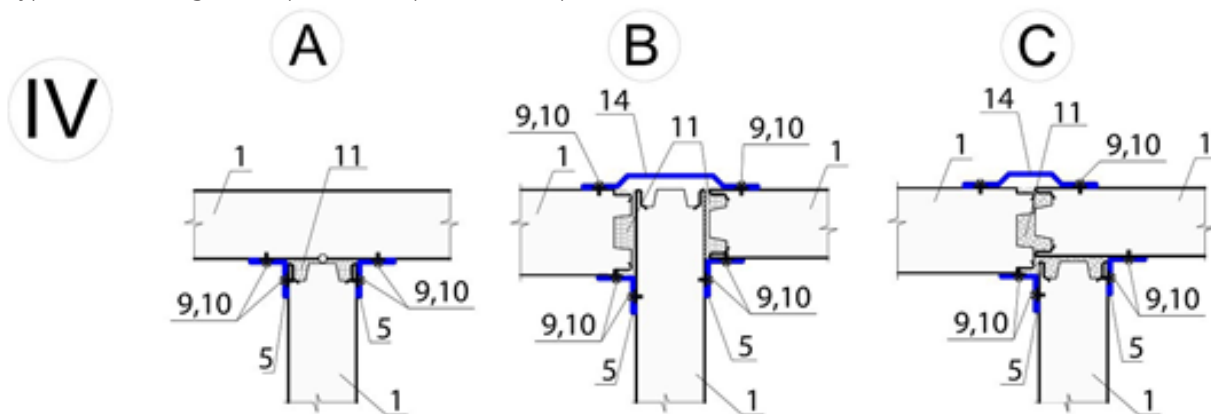

Figure 35.
Main joints of sandwich panels in a cold room (continued)

- | | |
|-----------------------------|--|
| 1. Wall panel | 9. Screws for metal elements (200–300 mm span) |
| 2. Floor panel | 10. All-purpose sealant |
| 3. Ceiling panel | 11. Construction foam |
| 4. Channel for wall panels | 12. Cut in metal face to prevent thermal bridges |
| 5. Inner angle, 40–40 mm | 13. Partition wall panel |
| 6. Unequal external angle | 14. Cover strip |
| 7. Equal external angle | |
| 8. Wedge bolt (450 mm span) | |

Types of fastening of wall panels and partition wall panels



Types of fastening of partition wall panels and ceiling panels

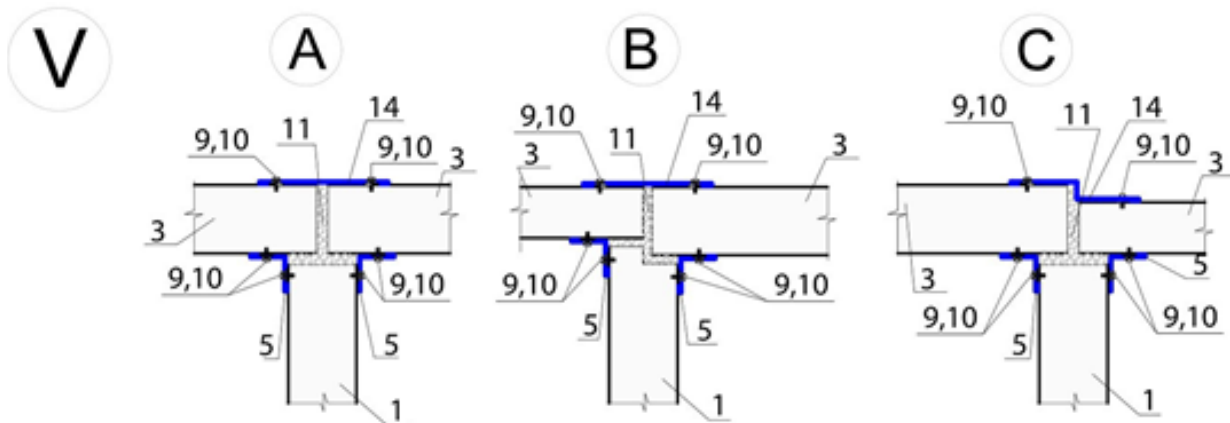

Types of fastening of partition wall panels and floor panels

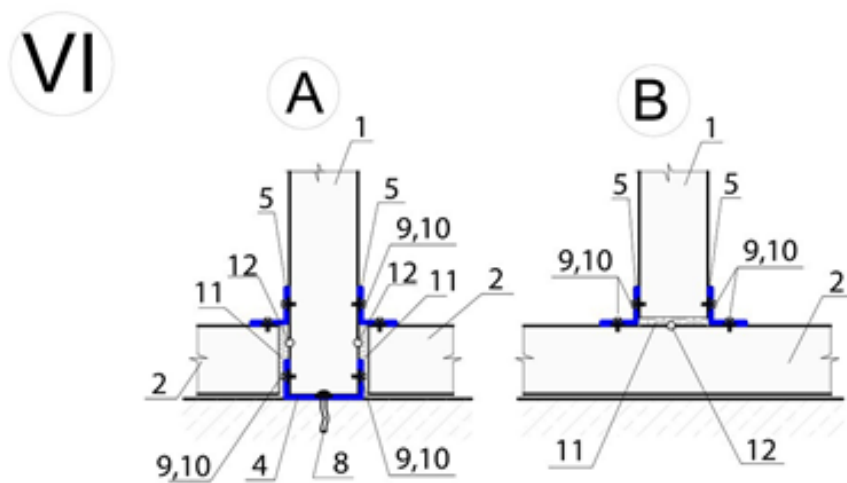

Channels for wall panels are bolted to the previously flattened floor along the perimeter of the assembled cold room. There are several options to connect the floor and wall panels to concrete.

Option I (B, C, D) is better for small structures; these connections naturally prevent thermal bridges, whereas the use of metal channels requires a special installation method.

To break a thermal bridge, the internal metal face of a wall panel is cut. If floor panels are used, it is recommended to make the cut somewhat higher than the channel, but not higher than the surface of floor panels. After that, the cold room is assembled according to the procedure starting from any corner or, if applicable, from the panel with a door opening.

Types of corner joints of wall panels are shown on Figures 34 and 35.

Option II (A-C). Tongues of wall panels are placed in the direction of assembly. Some construction foam is applied on the groove of the next panel, and the panel is placed in the channel and pressed into the previously installed panel.

The panels are then tightened and screwed to the channel. Make sure that all wall panels are vertical. After the cold chamber is ready, close all joints with a sanitary silicone sealant.

Panels are cut with a jigsaw or a circular saw with a special cutting blade. Door openings are cut with a jigsaw and framed with a U-shaped element made from two metal angles and a plastic profile.

Figure 36-1.
Profile for framing a window

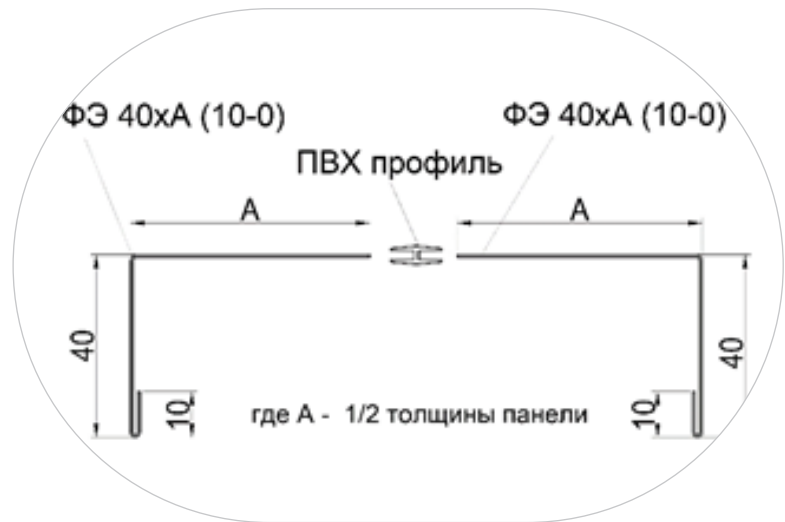

Figure 36-2.
Profile for framing a window



The length or width of the floor and ceiling panels should precisely fit the external or internal dimensions of the cold room. The type of installation is specified in the assembly diagram.

The vertical angles of the cold room are covered with metal elements; their color usually corresponds to that of external faces or wall panels.

The wings of external angles are 40 mm thicker than wall panels, which allows masking of the open edge of a panel in any type of installation. The angles are fastened to panels with thread-cutting screws or rivets. The ceiling panels are joined to the wall panels with horizontal angles.

The cold room may include several sections separated by partition walls. To reduce construction costs, panels of different thickness may be used (for example, 100 mm panels for a low-temperature room, and 80 mm panels for an adjacent middle-temperature room). However, this may lead to some inconveniences during installation, and either external or internal height should be prioritized.

All internal angles of the cold chamber are covered with 40-40 mm metal angles according to the diagram.

The floor panels should be strengthened with 1.5–4 mm plywood sheets or aluminum checker plates.

DO NOT use floor panels without this enhancement!

The dimensions of a frameless cold room are limited by the bearing strength of wall and ceiling or roof panels and by the location of the cold chamber.

PH Insulation strongly recommends making a metal framework for cold rooms with length and width dimensions of more than 6,000 mm and height over 4,000 mm.

Figure 37.
Aluminum checker plate for floor enhancement



If a cold room is assembled indoors, the following requirements should be met:

- The room should be dry and well-ventilated.
- The ratio of room volumes should be at least 1:3.5, or the room should be equipped with a balanced ventilation system. Otherwise, refrigeration may be disturbed, and energy costs may increase.
- The cold room should be located at least 0.1 m from the walls and 0.6 m from the ceiling of the room. The passage to the refrigerator should be at least 0.7 m wide. The cold room should be protected from direct sunlight and placed at least 1.5 m from heat sources.
- The floor in the room should be horizontal with a maximum 1% slope. Surface roughness should not exceed 2 mm.

Failure to meet these requirements may lead to shifts in the relative position of panels, which in turn leads to unsealing and increased energy costs.

Cold rooms installed outdoors under a cover should be placed on a flat concrete or asphalt-concrete surface; the roughness and slope of the floor should not exceed 3 mm and 1.5%, respectively.

Wind and snow load in the region of installation should be taken into account, as well as possible deflection due to temperature differences across panels. If an outdoor cold room is assembled using ceiling panels, these panels should be fully covered with waterproof materials. Although ceiling panels as such cannot substitute a roof, reliable waterproofing will make them suitable for this function.

6.3 METAL ELEMENTS OF COLD ROOMS

Figure 38.
Channels for panel installation

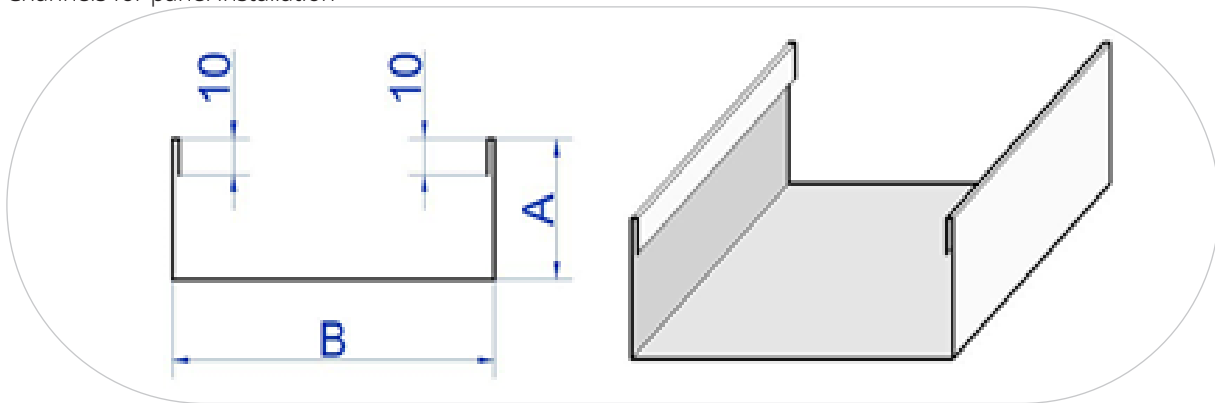

Table 36.
Channels for panel installation

A, mm	B,mm	Type	Mass per running meter, kg
40	42	Sh 40×42×40 Zn-0.45 (10-10)	0.50
	52	Sh 40×52×40 Zn-0.45 (10-10)	0.54
	62	Sh 40×62×40 Zn-0.45 (10-10)	0.57
	82	Sh 40×82×40 Zn-0.45 (10-10)	0.64
	102	Sh 40×102×40 Zn-0.45 (10-10)	0.71
	122	Sh 40×122×40 Zn-0.45 (10-10)	0.78
	142	Sh 40×142×40 Zn-0.45 (10-10)	0.85
	152	Sh 40×152×40 Zn-0.45 (10-10)	0.89
	162	Sh 40×162×40 Zn-0.45 (10-10)	0.93
	182	Sh 40×182×40 Zn-0.45 (10-10)	0.99
	202	Sh 40×202×40 Zn-0.45 (10-10)	1.07
50	42	Sh 50×42×50 Zn-0.45 (10-10)	0.57
	52	Sh 50×52×50 Zn-0.45 (10-10)	0.61
	62	Sh 50×62×50 Zn-0.45 (10-10)	0.64
	82	Sh 50×82×50 Zn-0.45 (10-10)	0.71
	102	Sh 50×102×50 Zn-0.45 (10-10)	0.78
	122	Sh 50×122×50 Zn-0.45 (10-10)	0.85
	142	Sh 50×142×50 Zn-0.45 (10-10)	0.89
	152	Sh 50×152×50 Zn-0.45 (10-10)	0.93
	162	Sh 50×162×50 Zn-0.45 (10-10)	0.99
	182	Sh 50×182×50 Zn-0.45 (10-10)	1.07
	202	Sh 50×202×50 Zn-0.45 (10-10)	1.13

Figure 39.
Equal angles (flat)

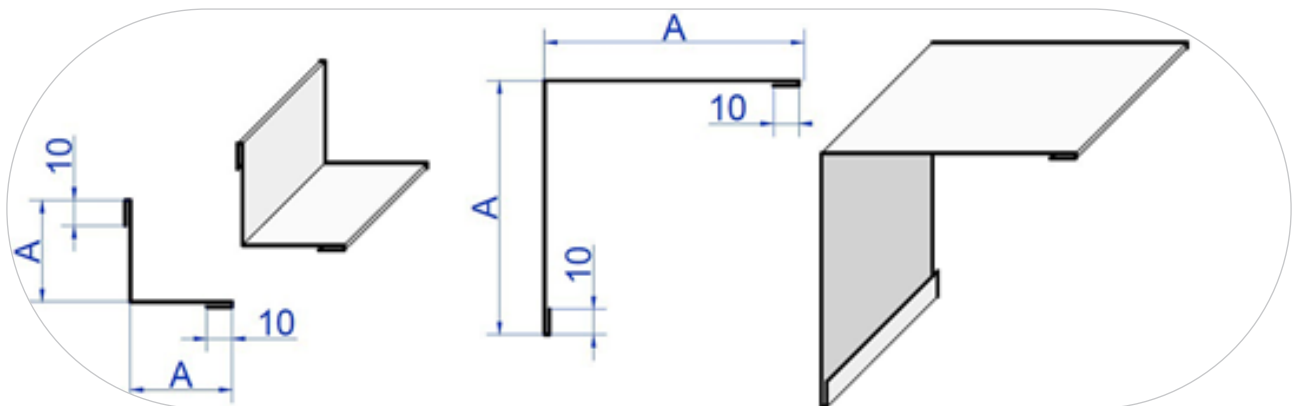

Table 37.
Equal angles (flat)

A, mm	Type (UV — internal angle, UN — external angle)	Mass per running meter, kg
40	UV (UN) 40×40 Zn-0.45 (10-10)	0.35
60	UV (UN) 60×60 Zn-0.45 (10-10)	0.49
80	UV (UN) 80×80 Zn-0.45 (10-10)	0.64
100	UV (UN) 100×100 Zn-0.45 (10-10)	0.77
120	UV (UN) 120×120 Zn-0.45 (10-10)	0.92
140	UV (UN) 140×140 Zn-0.45 (10-10)	1.05
160	UV (UN) 160×160 Zn-0.45 (10-10)	1.20
180	UV (UN) 180×180 Zn-0.45 (10-10)	1.34
200	UV (UN) 200×200 Zn-0.45 (10-10)	1.48
220	UV (UN) 220×220 Zn-0.45 (10-10)	1.62
240	UV (UN) 240×240 Zn-0.45 (10-10)	1.77

Figure 40.
Flat cover strip

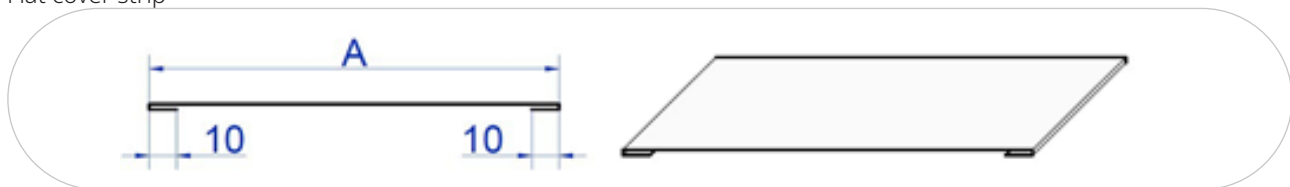

Table 38.
Flat cover strip

A, mm	Type	Mass per running meter, kg
40	N 40 Zn-0.45 (10-10)	0.21
60	N 60 Zn-0.45 (10-10)	0.28
80	N 80 Zn-0.45 (10-10)	0.35
100	N 100 Zn-0.45 (10-10)	0.42
120	N 120 Zn-0.45 (10-10)	0.49
140	N 140 Zn-0.45 (10-10)	0.56
150	N 150 Zn-0.45 (10-10)	0.60
160	N 160 Zn-0.45 (10-10)	0.64
180	N 180 Zn-0.45 (10-10)	0.70
200	N 200 Zn-0.45 (10-10)	0.77

Figure 41.
Unequal angles (for joints of ceiling and wall panels)

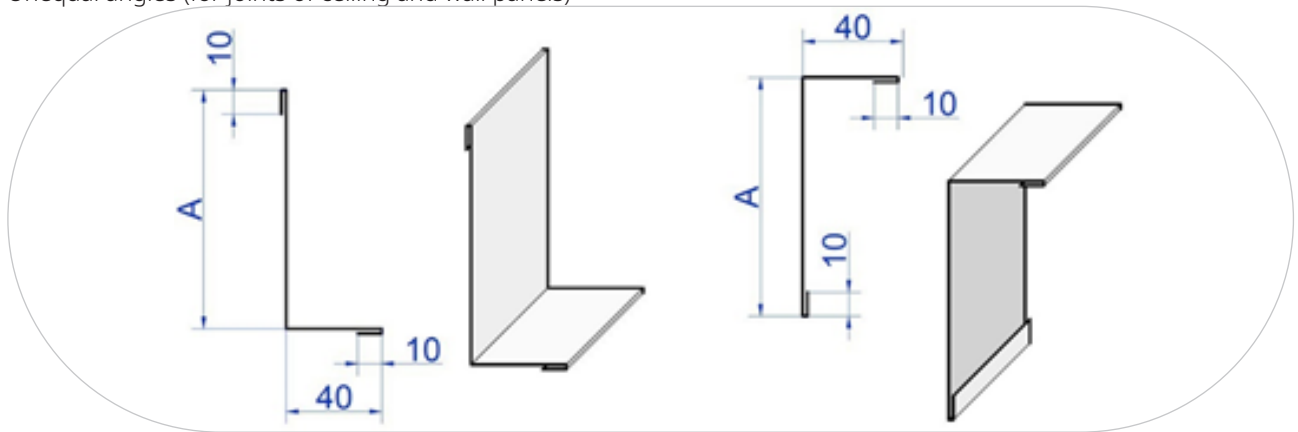

Table 39.
Unequal angles (for joints of ceiling and wall panels)

A, mm	Type Inner or outer angle	Mass per running meter, kg
60	UV (UN) 40×60 Zn-0.45 (10-10)	0.42
80	UV (UN) 40×80 Zn-0.45 (10-10)	0.49
100	UV (UN) 40×100 Zn-0.45 (10-10)	0.56
120	UV (UN) 40×120 Zn-0.45 (10-10)	0.66
140	UV (UN) 40×140 Zn-0.45 (10-10)	0.70
160	UV (UN) 40×160 Zn-0.45 (10-10)	0.78
180	UV (UN) 40×180 Zn-0.45 (10-10)	0.85
190	UV (UN) 40×190 Zn-0.45 (10-10)	0.88
200	UV (UN) 40×200 Zn-0.45 (10-10)	0.92
220	UV (UN) 40×220 Zn-0.45 (10-10)	0.99
240	UV (UN) 40×240 Zn-0.45 (10-10)	1.06

Figure 42.
Furring cover strip

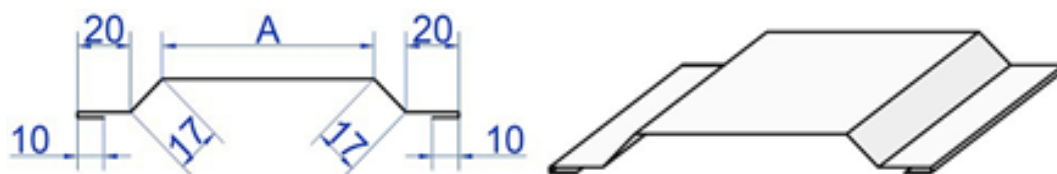

Table 40.
Furring cover strip

A, mm	Type	Mass per running meter, kg
40	N 20×17×40×17×20 10-10	0.47
60	N 20×17×60×17×20 10-10	0.54
80	N 20×17×80×17×20 10-10	0.61
100	N 20×17×100×17×20 10-10	0.69
120	N 20×17×120×17×20 10-10	0.76

140	N 20×17×140×17×20 10-10	0.83
160	N 20×17×160×17×20 10-10	0.90
180	N 20×17×180×17×20 10-10	0.97
200	N 20×17×200×17×20 10-10	1.04
220	N 20×17×220×17×20 10-10	1.11

6.4 INSULATION OF WALLS WITH SANDWICH PANELS

If a cold or deep-freeze chamber is assembled indoors and contacts concrete or brick walls, this influences its thermal insulation properties. Moreover, the layer of air between the panels and the wall may also be a factor to consider in calculations of thermal parameters of the cold chamber and choosing an appropriate thickness of panels.

If a panel of thickness δ_1 and thermal resistance R_1 closely contacts a wall of thickness δ and thermal conductivity α , the total thermal resistance of the layer composed of the panels and the wall is:

$$R_{\text{общ}} = \frac{\delta}{\alpha} + R_1 \quad (39)$$

Therefore, if we insulate, for example, a 450 mm brick wall (thermal conductivity of bricks = 0.37 W/m·K), then

$$R_{\text{общ}} = 1,22 + R_1 \quad (40)$$

Thermal conductivity of PU foam is 0.022 W/m·K, so the additional insulation provided by the brick wall will make it possible to choose a panel 25 mm thinner than that required for a free-standing cold room. However, this conclusion is true only if the panels tightly contact the brick wall. Otherwise cooling of the space between the wall and cold room may occur with subsequent damage of the panels.

In order to significantly reduce the costs of contraction, PH Insulation offers PIR Plita® boards (PIR Premier with foil or paper facing) for thermal insulation of walls and cold rooms. The material is fastened to a flattened wall with special corrosion-protected screws at least 3 cm longer than the thickness of the panels.

6.5 THICKNESS OF PANELS FOR COLD ROOMS

To choose the right panels for a frameless cold chamber, it is important to consider mechanical and thermal factors that influence the thickness of its walls.

Mechanical factors include:

- — wind load on walls and ceiling, if the cold room is placed outdoors
- load of the ceiling on the walls, which depends on the length and thickness of ceiling panels
- excessive external pressure on the cold room if pressure equalizing valves fail
- deflection and buckling due to temperature differences across panels
- deflection of panels because of their self-weight
- possible load on ceiling panels during installation

Thermal factors include:

- internal temperature;
- external temperature;
- volume of the cold chamber;
- material and thickness of the building, if applicable;
- type of products to be stored, daily turnover, etc.

The calculation of thermal balance in cold rooms is a separate engineering problem. However, a simple judgment helps to assess the feasibility of certain thicknesses of panels.

Obviously, the thicker the panel, the better its thermal insulation, therefore economic feasibility comes to the fore. It is usually assumed that an optimal thermal insulation for a cold room should reduce heat losses to 10 W/m² per hour.

This value is also called thermal load or heat demand to be met in order to maintain a required temperature inside. Table 41 shows design thermal losses for panels of various thicknesses depending on the temperature differences across the wall of a cold store. It should be used only for cold rooms and warehouses, and does not apply to office and utility buildings.

Table 41.
Choice of wall thickness for cold chambers based on the temperature difference across its wall

		Panel thickness, mm										
		40	50	60	80	100	120	140	150	160	180	200
Temperature difference	10°C	5.30	4.20	3.50	2.60	2.10	1.70	1.50	1.40	1.30	1.20	1.00
	15°C	7.90	6.30	5.25	3.90	3.15	2.55	2.25	2.10	1.95	1.80	1.50
	20°C	10.50	8.40	7.00	5.20	4.20	3.40	3.00	2.80	2.60	2.40	2.00
	25°C	13.10	10.50	8.75	6.50	5.25	4.25	3.75	3.50	3.25	3.00	2.50
	30°C	15.80	12.60	10.50	7.80	6.30	5.10	4.50	4.20	3.90	3.60	3.00
	35°C	18.40	14.70	12.25	9.10	7.35	5.95	5.25	4.90	4.55	4.20	3.50
	40°C	21.00	16.80	14.00	10.40	8.40	6.80	6.00	5.60	5.20	4.80	4.00
	45°C	23.60	18.90	15.75	11.70	9.45	7.60	6.75	6.30	5.85	5.40	4.50
	50°C	26.30	21.00	17.50	13.00	10.50	8.50	7.50	7.00	6.50	6.00	5.00
	55°C	28.90	23.10	19.25	14.30	11.55	9.35	8.25	7.70	7.15	6.60	5.50
	60°C	31.50	25.20	21.00	15.60	12.60	10.20	9.00	8.40	7.80	7.20	6.00
	65°C	34.10	27.30	22.75	16.90	13.65	11.05	9.75	9.10	8.45	7.80	6.50
	70°C	36.80	29.40	24.50	18.20	14.70	11.90	10.50	9.80	9.10	8.40	7.00
	75°C	39.40	31.50	26.20	19.50	15.70	12.70	11.25	10.50	9.75	9.00	7.50
	80°C	42.00	33.60	28.00	20.80	16.80	13.60	12.00	11.20	10.40	9.60	8.00
	85°C	44.60	35.70	29.80	22.10	17.90	14.50	12.80	11.90	11.00	10.20	8.50
	90°C	47.30	37.80	31.50	23.40	15.30	15.30	13.50	12.60	11.70	10.80	9.00
	95°C	49.90	39.90	33.30	24.70	19.90	16.20	14.30	13.30	12.40	11.40	9.50

	Optimal thickness
	Excessive thickness (possible)
	Not recommended

6.6 PRESSURE EQUALIZING VALVES

Pressure equalizing valves are installed in low-temperature cold rooms.

When the air is cooled, the pressure inside decreases. It is not a problem in case of small chambers (up to several cubic meters) and cold rooms that have significant constructive rigidity. However, these pressure differences make it hard to open a well-sealed door to a large cold room, and this results in frequent breakages of door handles and locks.

In low-temperature cold rooms, pressure equalizing valves with freeze protection are required, which can operate in any conditions. For better reliability, large cold rooms are equipped with several such valves.

To equalize the pressure inside low-temperature stores, metal and silicone valves may be used. Metal valves close under gravity, so they are installed horizontally in ceiling panels, which is not always convenient. Silicone valves function in a vertical position, which makes them easier to install in wall panels.

The efficiency of pressure equalizing valves is chosen based on the volume of the cold room.

Image 9.
KVD-4-60 pressure equalizing valve



The amount of air required to equalize internal and external pressure is calculated as follows:

$$Q = K \cdot V \cdot \Delta T \quad (41)$$

where Q = amount of air required in l/min; K = 3.66 (constant); V = volume of cooled room in m³; ΔT = maximum temperature change in the cooled room in °C (not to be confused with temperature difference across the wall of the cold room).

The lack of pressure equalizing valves may lead to serious damage for the entire structure. The valves are fastened with bolts, and the space between the wall panel and the valve is sealed. The valves are placed across the airflow from coolers beside the door. In cold chambers smaller than 120 m³, the valves are placed at least 30 cm from the floor and ceiling; in cold rooms up to 600 m³, the distance should be at least 50 cm. Do not block the valves or limit the airflow through them. The valves are supplied with 230V.

PLEASE NOTE: Installation of pressure equalizing valves in the wrong position may lead to their freezing and malfunction.

REFERENCES

- Allen, H.G., Analysis and Design of Structural Sandwich Panels, 1993.
- Bogoslovskii, V. N., Stroitel'naia teplofizika [Thermal Physics in Construction], 1982.
- Damen, G., Kassel'man, Kh.-F., Polents, R., & Shil'd, E., Stroitel'naia fizika [Physics in Construction], 1982.
- Davies, J. M., Lightweight Sandwich Construction, 2001.
- DIAB Sandwich Handbook — DIAB Group.
- Dekhtyar, A. Sh., Oblegchennye konstruksii metallicheskih sten promyshlennykh zdanii [Lightweight Structures of Metal Walls of Industrial Buildings], 1979.
- EN 14509-2006: Self-supporting double skin metal faced insulating panels — Factorymade products — Specifications, 2006.
- Keller, P., Lazutin, M., & Ottens, A., Teplovaia izoliatsiia iz zhestkogo poliuretana: osnovnye svoistva i napravleniia primeneniia v stroitel'stve [Thermal insulation with Rigid Polyurethane: Main Properties and Areas of Application in Construction], Energoberezhenie, 2002, №3.
- Koschade, R., Construction with Factory Engineered Sandwich Panels, 2006.
- Shtamm, K. & Vitte, Kh., Mnogosloinnye konstruksii [Multilayer Structures], 1983.
- Wiesinger, R., Sandwich Panels Application Guide, 2009.

Copyright (c) 2021 OOO ProfHolod

No part of this publication may be reproduced or transmitted in any form or by any means, except as permitted by OOO ProfHolod.